







**Investigation Report on  
Prestressing Tendon Failure Incident at  
Concrete Viaduct of Shenzhen Bay Bridge  
- Hong Kong Section**

This Report is jointly prepared by the Investigation Team as follows and all members hereby confirm their agreement to the content herein :

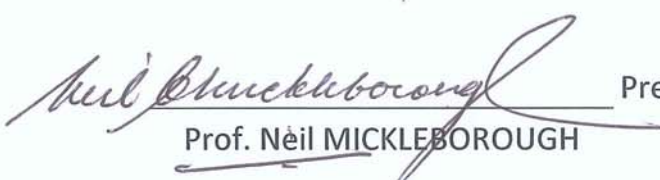
	<u>Name &amp; Signature</u>	<u>Post</u>	<u>Date</u>
Chairman :	 Mr. Harry H. N. MA	AD/D, HyD	<u>18 Jun 2019</u>
Members :	 Prof. Francis T. K. AU	Expert on Bridges	<u>18 June 2019</u>
	 Prof. Neil MICKLEBOROUGH	Expert on Prestressing Systems	<u>June 18<sup>th</sup> 2019</u>
	 Dr. Eric C. H. LIM	Expert on Materials	<u>18/6/2019</u>
	 Mr. Kenneth W. Y. CHAN	CHE/B&S, HyD	<u>18 June 2019</u>
	 Mr. K.Y. YUNG	PPC/CB, HyD	<u>18 June, 2019</u>
	 Mr. P. H. CHUNG	SE/BTA, HyD	<u>18 June 2019</u>

# CONTENT

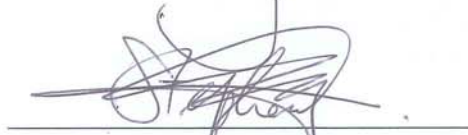
<b>EXECUTIVE SUMMARY .....</b>	<b>1</b>
<b>1. INTRODUCTION .....</b>	<b>3</b>
1.1 OBJECTIVE OF INVESTIGATION .....	3
1.2 THE INVESTIGATION TEAM .....	3
1.3 BACKGROUND INFORMATION .....	4
<b>2. APPROACH OF INVESTIGATION .....</b>	<b>11</b>
<b>3. INVESTIGATION FINDINGS .....</b>	<b>14</b>
3.1 CONSTRUCTION MATERIALS .....	14
3.2 STRUCTURAL DESIGN.....	23
3.3 CONSTRUCTION PROCESS.....	24
3.4 MAINTENANCE ARRANGEMENT.....	33
<b>4. CAUSES OF TENDON FAILURE.....</b>	<b>35</b>
4.1 ANALYSIS OF TENDON FAILURE .....	35
4.2 CONCLUDED CAUSES OF TENDON FAILURE .....	38
<b>5. MEASURES TAKEN/ TO BE TAKEN AFTER THE INCIDENT .....</b>	<b>40</b>
5.1 SHORT TERM .....	40
5.2 MEDIUM TO LONG TERM.....	42
<b>6. CONCLUSIONS .....</b>	<b>44</b>

## **List of Figures**

- Figure 1 Overview of Shenzhen Bay Bridge
- Figure 2 Location Plan of Shenzhen Bay Bridge
- Figure 3 Elevation of Shenzhen Bay Bridge
- Figure 4 Location of Ruptured Tendon
- Figure 5 Cross-sectional Details of Tendon T3
- Figure 6 Location Plan of Piers P1 and P5
- Figure 7 Longitudinal Profile of Tendon T3 between Piers P1 and P5
- Figure 8 End view at Pier P5 with Location of Ruptured Tendon T3
- Figure 9 Photo at Pier P5 with Location of Ruptured Tendon T3
- Figure 10 Details of Anchor Head at P5
- Figure 11 General view of broken strands at anchor head P5
- Figure 12 Broken strands with significant reduction in cross section
- Figure 13 Ruptured wires pulled out from anchor head
- Figure 14 Broken corroded wires with cup-and-cone failure feature
- Figure 15 Condition of steel strands at anchor head P1 (with embedded grouts removed)
- Figure 16 Condition of the inner surface of the end plate at anchor head P5
- Figure 17 Residue found at the bottom of trumpet at anchor head P5
- Figure 18 (Left) Anchor head P5 rendered with cement mortar; (Right) P5 wedge area after removal of mortar with the air release tube exposed
- Figure 19 Air release tube at anchor head P5
- Figure 20 Trace of residue within air release tube at anchor head P5
- Figure 21 Condition of wedges at anchor head P1
- Figure 22 Condition of the air release tube at the cap of anchor head P1
- Figure 23 Locations of grout samples taken for SEM analysis
- Figure 24 (Left) Grout Injection Point observed on ruptured Tendon T3; (Right) Trace of grout injection points of tendons on symmetrical parallel side
- Figure 25 Trace of grout Injection point at Tendon T3
- Figure 26 Sequence 1 – Trimming of strands after stressing
- Figure 27 Sequence 2 – Patching up anchor head outer face with cement mortar
- Figure 28 Sequence 3 – Installation of anchor head cap
- Figure 29 Sequence 4 – Water test to ensure no leakage in duct
- Figure 30 Sequence 5 – Drain all water out after confirmation of no leakage in duct
- Figure 31 Sequence 6 – Grout commenced from low point towards anchor head P5
- Figure 32 Sequence 7 – Grout approached anchor head P5

- Figure 33 Sequence 8 – Grouting operation within the tendon duct completed (Expected Condition)
- Figure 34 Sequence 9 – Anchor protection cap subsequently filled up by grout under a separate operation (Expected Condition)
- Figure 35 Sequence 8A – Grout approached anchor head P5 with a surge (Estimated Condition)
- Figure 36 Sequence 9A – Grouting operation stopped and anchor protection cap subsequently filled up by grout (Estimated Condition)
- Figure 37 Corrosion development on steel strands of tendon T3 near anchor head P5 at the voided region with free-water from bleeding and trapped air pocket

### **List of Tables**

- Table 1 Technical Details in relation to the construction of Tendon T3

### **List of Appendices**

- Appendix A – Material Test Results
- Appendix B – Method Statement for External Prestressing Work
- Appendix C – List of Highway Bridges with External Prestressing Tendons

## EXECUTIVE SUMMARY

During a routine site inspection on 15 February 2019, a Highways Department (HyD) site staff discovered an external prestressing tendon at the concrete viaduct of Shenzhen Bay Bridge (Hong Kong Section) (as known as SBB-HK) Hong Kong bound being ruptured (the “Incident”).

Immediately after the Incident, the maintenance contractor and the designer of SBB-HK took prompt actions to examine the structural integrity of the bridge structure and arranged for urgent replacement of the broken tendon. It is confirmed that bridge structure remained structurally adequate under the situation. HyD had set up an Investigation Team led by an Assistant Director with three experts involved to carry out independent investigation on the possible causes of the Incident.

The investigation conducted review on four aspects: the construction materials, the structural design, the construction process, and the maintenance of the bridge. The Investigation Team collected samples for material testing, reviewed the design of the external prestressing system, examined construction records and work sequences and reviewed the maintenance arrangement and records. Interviews were also conducted with the consultants and the specialist subcontractor of the construction works. The Investigation Team has determined that the mode of failure was due to corrosion attack on the steel strands causing deterioration of their structural load capacity. According to detailed investigation on the materials, site evidence, site records and method statements, the Investigation Team established that the Incident was due to a combination of factors including the probable partial blockage of the air release tube at anchor head P5 during the grouting operation, coupled with a gradually reduced grouting pressure along the long grouting length, leading to the presence of an air pocket at the anchorage region and subsequently causing corrosion of the steel strands in that area. The reduction in sectional area thus load carrying capacity of the steel strands due to corrosion resulted in the rupture of the tendon near anchor head P5.

With reference to the investigation findings, the Investigation Team recommended short term measures, including inspection of other external tendons on SBB-HK. The Investigation Team also recommended medium to long-term measures, such as inspection of other bridges with external prestressing tendons in Hong Kong, review on the prestressing and grouting specifications as well as consideration of introducing intelligent monitoring system for long term monitoring of external prestressing tendons.

## 行政摘要

路政署人員於 2019 年 2 月 15 日在深圳灣公路大橋香港段(簡稱「大橋香港段」)進行例行檢查時，發現往香港行車方向的一段混凝土高架橋內，一條外置式預應力鋼纜斷裂(下稱「鋼纜事件」)。

在發現事故後，大橋香港段的保養承辦商及設計工程師隨即採取跟進行動，檢視大橋的結構安全，並安排緊急更換該條受損鋼纜。檢查後確認大橋結構在現有情況下仍然安全。路政署成立了調查工作小組，小組由一名助理署長帶領，並有三名專家參與，進行獨立的調查工作，以找出鋼纜事件的成因。

調查工作就四個範疇進行檢視：包括橋樑的建造物料、結構設計、建造過程及維修保養事宜。調查小組收集樣本以進行物料測試，檢視外置式預應力系統的設計，翻查施工記錄和程序，並檢視維修保養安排和記錄。調查工作亦包括與建造工程的顧問及專門工程分包商面談。調查小組認為，損毀是由於鋼纜的鋼絞線鏽蝕引致結構承載能力下降。根據有關物料、現場證據、工地記錄及施工說明書的詳細調查結果，小組認為事故是由於多項因素導致，包括進行灌漿期間位於 P5 號錨碇的排氣管有機會局部堵塞，加上灌漿壓力隨着灌漿長度而逐漸下降，引致氣囊積聚在錨碇的位置，隨後令該處的鋼絞線鏽蝕。由於鋼絞線截面面積因鏽蝕而減少，以致其承載能力相應下降，最後導致 P5 號錨碇內的鋼纜折斷。

根據調查工作所得的結果，調查小組建議了若干短期措施，包括檢查大橋香港段其他外置式鋼纜，同時提議了多項中長期措施，包括檢查香港其他採用外置式預應力鋼纜設計的橋樑、檢視預應力系統和灌漿工序的規格說明，以及考慮利用智能監測系統，長期監察外置式預應力鋼纜的狀況。

## **1. INTRODUCTION**

### **1.1 Objective of Investigation**

1.1.1 The objective of this independent investigation is to identify the causes of the prestressing tendon failure incident at the concrete viaduct of the Shenzhen Bay Bridge (Hong Kong Section) (hereinafter referred to as “the Incident”) discovered on 15 February 2019 and to recommend any follow up action required.

### **1.2 The Investigation Team**

1.2.1 The Shenzhen Bay Bridge Hong Kong Section Concrete Viaduct Prestressing Tendon Failure Investigation Team (hereinafter referred to as “the Investigation Team”) was set up by the Highways Department (HyD) on 22 February 2019. The Investigation Team is led by an Assistant Director of HyD with members of experts on bridges, prestressing systems and materials.

1.2.2 Three experts, Professor Francis AU Tat-kwong, Adjunct Professor Neil Colin MICKLEBOROUGH and Dr. Eric LIM Chaw-hyon with expertise on bridges, prestressing systems and materials respectively, had been engaged as members of the Investigation Team :

- Professor Francis AU is the Head of Department of Civil Engineering at the University of Hong Kong. He possesses over 38 years of engineering expertise in bridge engineering and concrete structures. Professor Au has provided expert advice on bridge structural design, bridge health monitoring and maintenance of bridges in Hong Kong.
- Adjunct Professor Neil Colin MICKLEBOROUGH of the Hong Kong University of Science and Technology (HKUST) was a former Professor and Director of the Center of Engineering Education Innovation of the School of Engineering of the HKUST. He has been actively involved in the research, development and teaching of prestressed and reinforced concrete, structural analysis and bridge design in Australia, Asia and the Middle East for the past 30 years. He has acted as an expert design consultant on long-span bridge projects in both Dubai and Hong Kong.



- Dr. Eric LIM is an expert in material testing and material failure analysis. Dr. Lim possesses 20 years of engineering experience and has provided expert advice on numerous engineering investigations in Hong Kong. He was a former Visiting Associate Professor of the Department of Mechanical Engineering of the University of Hong Kong.

### **1.3 Background Information**

#### ***Shenzhen Bay Bridge***

1.3.1 The Shenzhen Bay Bridge carries a dual three-lane carriageway of about 5.5 kilometres (km) long, spanning across Deep Bay between Lau Fau Shan of Hong Kong and Shekou of Shenzhen. The bridge consists of two sections, namely the Hong Kong Section (SBB-HK) and the Shenzhen Section, having a length of 3.5km and 2km respectively. The bridge takes the form of a multi-span concrete viaduct except that at the two navigation channels where cable-stayed steel bridge form is adopted to meet the longer-span requirements. An overview, location plan and elevation of the Shenzhen Bay Bridge are shown in Figures 1, 2 and 3 respectively.



**Figure 1 Overview of Shenzhen Bay Bridge**

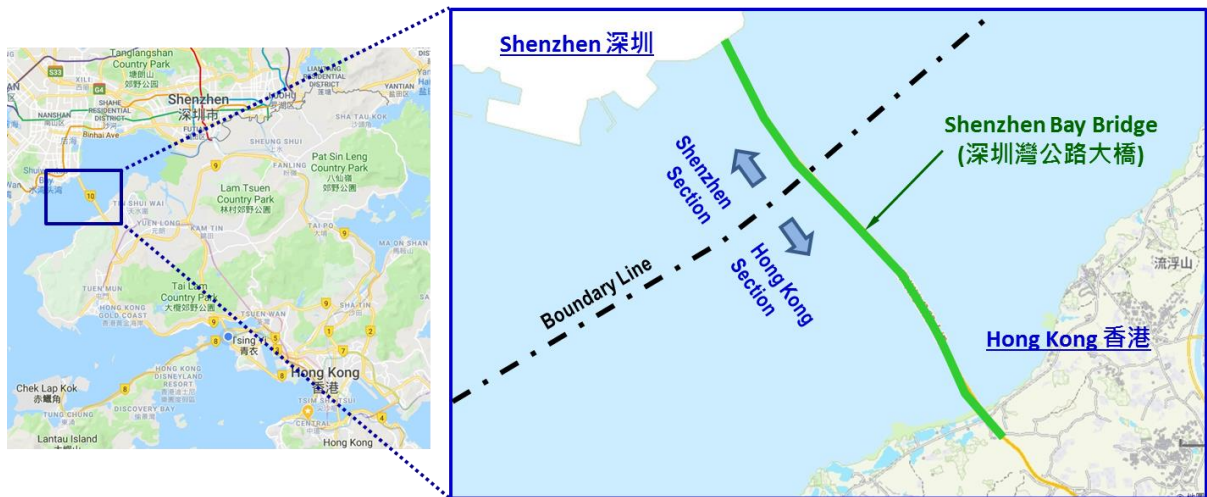

Figure 2 Location Plan of Shenzhen Bay Bridge

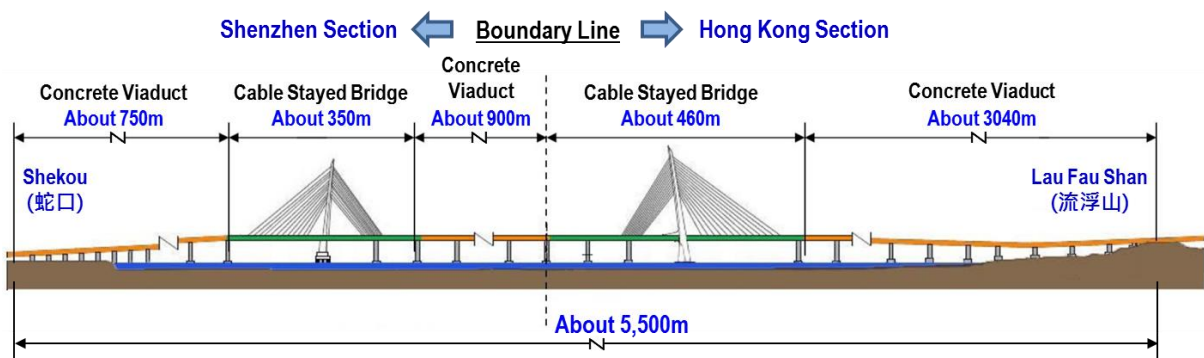

Figure 3 Elevation of Shenzhen Bay Bridge

1.3.2 The concrete viaduct of the SBB-HK is a twin deck structure with a single-cell trapezoidal box girder constructed by the precast segmental method. The precast bridge segments were assembled by a number of internal and external prestressing tendons<sup>1</sup>. Ove Arup & Partners Hong Kong Limited was employed by HyD as the engineering consultant to design the SBB-HK and supervise the relevant construction works. The construction contract of the SBB-HK was awarded to Gammon-Skansa-MBEC Joint Venture, who

<sup>1</sup> Internal prestressing tendons are embedded inside the bridge deck section and bonded with the concrete structure. They were designed for taking the dead load of the bridge as well as the loadings during the construction process. External prestressing tendons are placed outside of the bridge deck section with the stressing force being transferred to the concrete structure via the anchorage blocks and deviators. They were designed essentially for taking the live load at the service stage.

appointed VSL Hong Kong Limited<sup>2</sup> as their specialist subcontractor responsible for the tendon prestressing and grouting works of the SBB-HK. The SBB-HK commenced construction in August 2003 and commissioned in July 2007.

### Ruptured Tendon

1.3.3 During a routine site inspection on 15 February 2019, a HyD site staff discovered an external prestressing tendon at the concrete viaduct of SBB-HK Hong Kong bound being ruptured. The location of the ruptured tendon is shown in Figure 4.

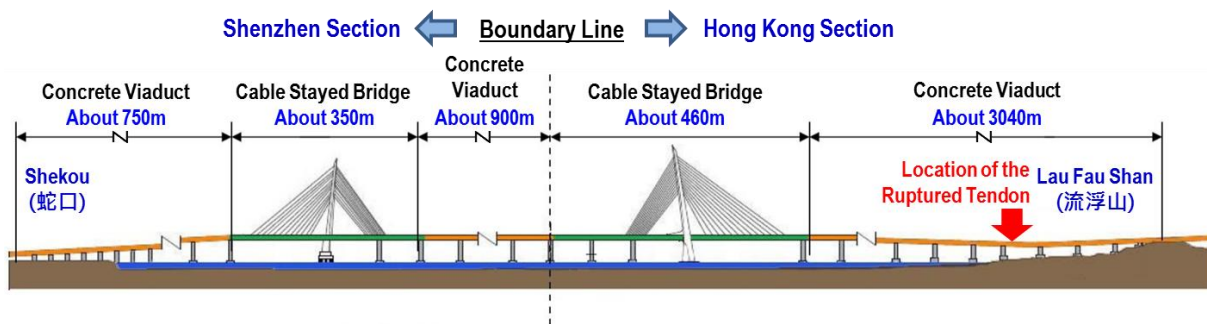

Figure 4 Location of Ruptured Tendon

1.3.4 The ruptured tendon (named as Tendon T3) consists of thirty-seven 15.7 millimetres (mm) nominal diameter 7-wire steel strands, each with a capacity of minimum breaking load of 279 kilonewtons (kN) enclosed in a high-density polyethylene (HDPE) duct of outer diameter 160 mm filled with cementitious grout materials. The tendon is about 280 metres (m) in length spanning from Pier P1 to Pier P5 on Bridge B2 of the SBB-HK (i.e. the SBB-HK Hong Kong bound concrete viaduct section). The cross-section of Tendon T3 and the location plan of Pier P1 and Pier P5 are shown in Figures 5 and 6 respectively.

<sup>2</sup> VSL International is a Switzerland based company found in 1954. The company is a specialist construction company specialised in post-tensioned concrete, stay-cable systems and has developed a series of proprietary system widely adopted internationally. The company's global network comprises local offices in 36 countries and places. VSL Hong Kong Limited was founded in Hong Kong in 1973 and is supported by VSL's global network.

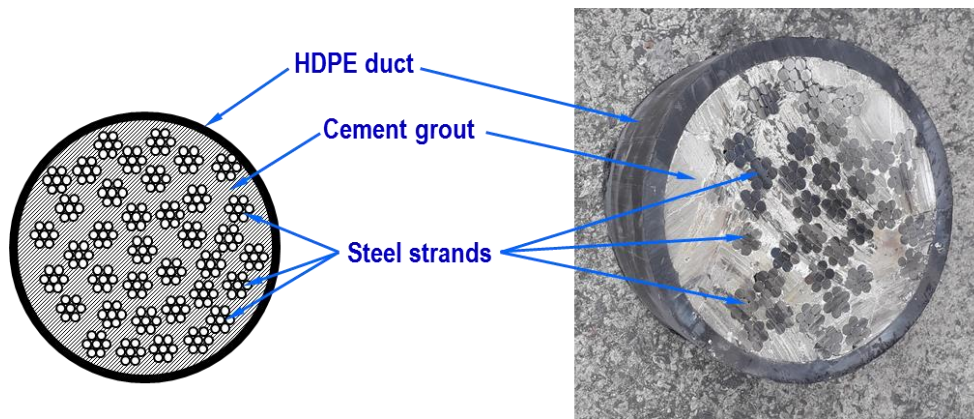

Figure 5 Cross-sectional Details of Tendon T3

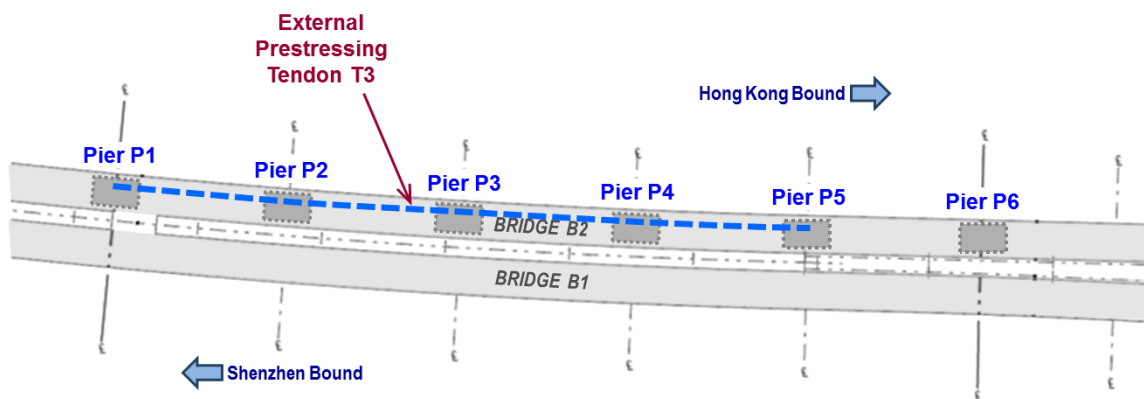

Figure 6 Location Plan of Piers P1 and P5

1.3.5 Bridge B2 extending from Pier P1 to Pier P6 comprises five 70m-long spans with a total length of 350m. It is structurally separated from other bridges by movement joints at Piers P1 and P6. Each span has a diaphragm segment above its pier and two internal deviators. There are a total of 8 pairs of external tendons (namely Tendons T1 to T8) with high points at the pier diaphragms and low points between the internal deviators. Among these tendons, Tendon T3 is the longest which continues over 4 spans. A longitudinal profile of Tendon T3 between anchorage at Pier P1 and anchorage at Pier P5 is shown in Figure 7.

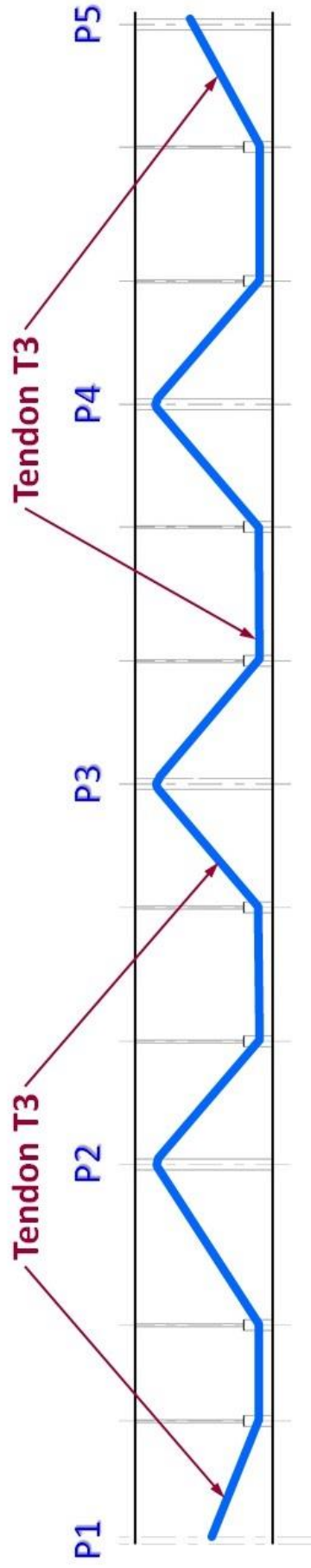

Figure 7 Longitudinal Profile of Tendon T3 between Piers P1 and P5

1.3.6 The bridge deck structure of Bridge B2 is 15m wide with a single-cell trapezoidal box girder section of 3.8m deep. A cross section and photo of the bridge deck at Pier P5 where Tendon T3 ruptured are shown in Figures 8 and 9, and the typical anchorage details of the tendon at anchorage is shown in Figure 10.

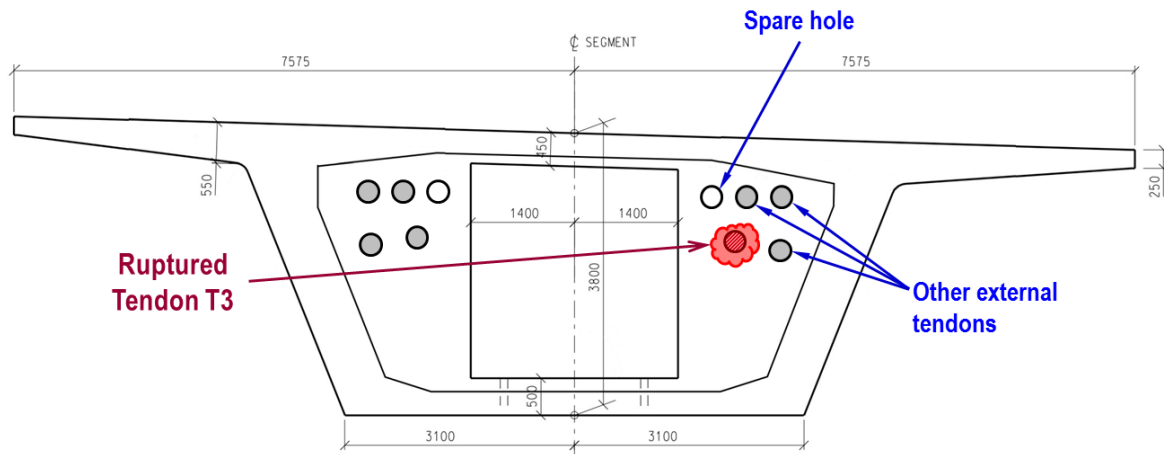
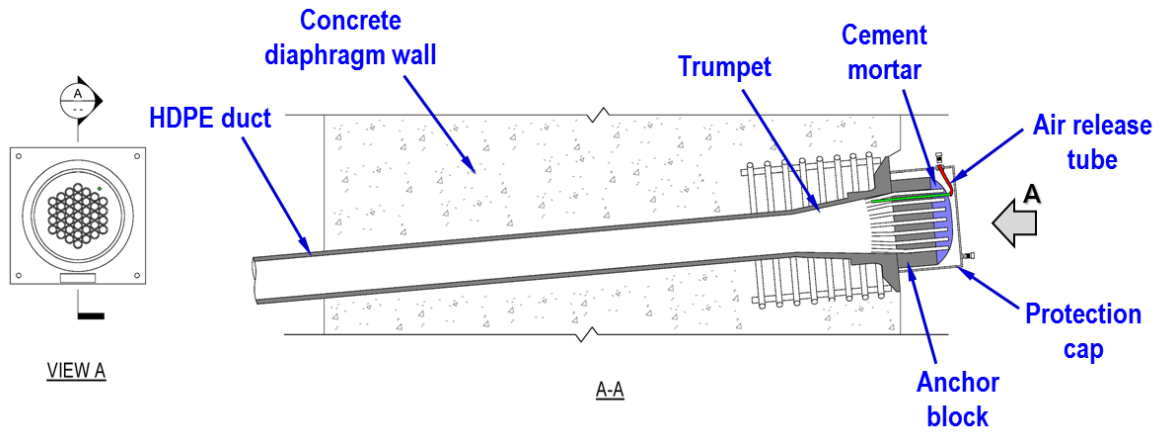

Figure 8 End view at Pier P5 with Location of Ruptured Tendon T3



Figure 9 Photo at Pier P5 with Location of Ruptured Tendon T3



**Figure 10 Details of Anchor Head at P5**

1.3.7 Technical details in relation to the construction of Tendon T3 are summarised in Table 1 below.

Year of installation	2005
Main contractor	Gammon-Skanska-MBEC Joint Venture
Specialist subcontractor	VSL Hong Kong Limited
Consultants	Ove Arup & Partners Hong Kong Limited
Length of tendon	About 280 m between Pier P1 and Pier P5
Diameter of tendon	160 mm (i.e. external diameter of HDPE duct)
Number of strands	37
Type of strands	15.7mm nominal diameter 7-wire steel strands
Specified characteristic breaking load per strand	279 kN
Protection measures	Steel strands encased in HDPE duct filled with cementitious grout material

**Table 1 Technical Details in relation to the construction of Tendon T3**

## **2. APPROACH OF INVESTIGATION**

2.1 The Investigation Team conducted review on four possible aspects relating to the failure of the tendon. These aspects include (1) the construction materials; (2) the structural design; (3) the construction process; and (4) the maintenance of the bridge. The Investigation Team collected samples for material testing, reviewed the design of the prestressing system, examined the construction records and works sequences and reviewed the maintenance arrangement and records. The approach of the investigation is further elaborated below.

### **2.2 Investigation Approach**

#### **2.2.1 Inspection of the ruptured Tendon T3 and the anchor heads at P1 and P5**

The Investigation Team inspected the ruptured Tendon T3 and its anchor heads at Piers P1 and P5 (hereinafter referred to as “anchor head P1” and “anchor head P5”). The exposed steel strands, grout material, residue left around the steel strands and the anchor areas, the anchor trumpets, anchor heads and anchor protection caps at Piers P1 and P5 were examined. Samples of steel strands, grout, cement mortar and residue were collected at various locations.

#### **2.2.2 Collection of samples for material testing**

The Investigation Team conducted material testing for the ruptured Tendon T3, including tensile testing of the intact section of the steel strands, scanning electron micrography (SEM) and energy dispersive X-Ray analysis (EDAX) of the ruptured steel surface, chloride content and pH analysis as well as SEM of the grout materials, cement mortar and residue collected. Tensile tests were carried out on samples from the “intact” section of the ruptured tendon to determine the breaking load and other properties to identify the material conditions before failure. The tensile tests were conducted by the Public Works Central Laboratory. Chemical tests, including Chloride content test and pH value test, were carried out on the fractured grout materials to identify composition of rust-inducing agents in grout material. The Chloride content test was conducted by Public Works Central Laboratory, while the pH value test was conducted by the Civil and Environmental Engineering Department of the Hong Kong University of Science and Technology (HKUST). SEM was conducted to characterize the fracture morphology of individual



corroded steel wire samples by using magnification to identify any signs of stress corrosion cracking. EDAX was also conducted to determine any signs of foreign chemical species on these samples. Both the SEM and the EDAX were conducted by the laboratory of the Hong Kong Productivity Council (HKPC).

#### 2.2.3 Checking of design calculation of Bridge B2

The Investigation Team reviewed the design of Bridge B2 and checked whether the design was carried out in accordance with the design standards and relevant parameters as adopted for the project. Information including design calculations and design drawings was retrieved and examined.

#### 2.2.4 Survey Checking

In order to verify that the tendon was constructed strictly in accordance with the designed profile, a site survey was conducted to examine the as-built profile of the tendon and the positions of the anchor heads and deviators on Bridge B2.

#### 2.2.5 Retrieval of technical information

The Investigation Team retrieved information relating to the technical specifications and engineering drawings for the relevant section of the bridge under the construction contract. Information collected was used to check against the design, the material testing results and the site arrangement.

#### 2.2.6 Retrieval of site records

The Investigation Team reviewed all available site records retrieved from the Tuen Mun Government Records Management Office and in HyD's maintenance depot at Shenzhen Bay Port. Site records in 21 boxes from Tuen Mun Government Records Management Office and 26 boxes from HyD's maintenance depot at Shenzhen Bay Port dated back to 2002, including inspection forms for grouting works, site dairies, stressing reports and material test certificates relating to the tendon installation and grouting works were examined. Furthermore, the method statements and technical specifications for construction of external tendons were reviewed.

#### 2.2.7 Interview with the consultant and specialist subcontractor

The Investigation Team interviewed staff from Ove Arup Hong Kong Limited for the construction works of SBB-HK with a view to acquiring further information on their supervision during the construction process. The

Investigation Team also interviewed the specialist subcontractor for the prestressing tendon construction works of SBB-HK, the VSL Hong Kong Limited, with a view to obtaining more information relating to the site conditions and construction practices during the time of construction in 2004. However, the personnel involved directly for the SBB-HK project at the time of construction had either retired or left the company. The interviews could not collect first-hand information directly relating to the practice and conditions of stressing and grouting of Tendon T3 at the time of construction.

#### 2.2.8 Review of maintenance and inspection records

The Investigation Team examined the inspection and maintenance records of Bridge B2 with a view to reviewing the adequacy and extent of the inspection and maintenance activities conducted for the structure.

### 3. INVESTIGATION FINDINGS

#### 3.1 Construction Materials

##### *Structural concrete*

3.1.1 The Investigation Team conducted a field inspection on the structural concrete of Bridge B2 where the tendon T3 is located and did not reveal any observable defect. The Investigation Team also conducted Schmidt hammer tests on the structural concrete which did not indicate any abnormality on concrete strength.

##### *Steel Strands*

3.1.2 Inspection of the ruptured Tendon T3 revealed the followings:

- (i) The steel strands at anchor head P5 had failed along a plane from the top at approximately 0.7 metre from the anchor head to about half height of the end plate as shown in Figure 11. The strands at the lower half had mainly failed by tension at the anchor head. Signs of corrosion were found on most of the wires at the upper half of the anchor head but not for those at the lower half that were totally embedded in the grout encasing the tendon along its length.

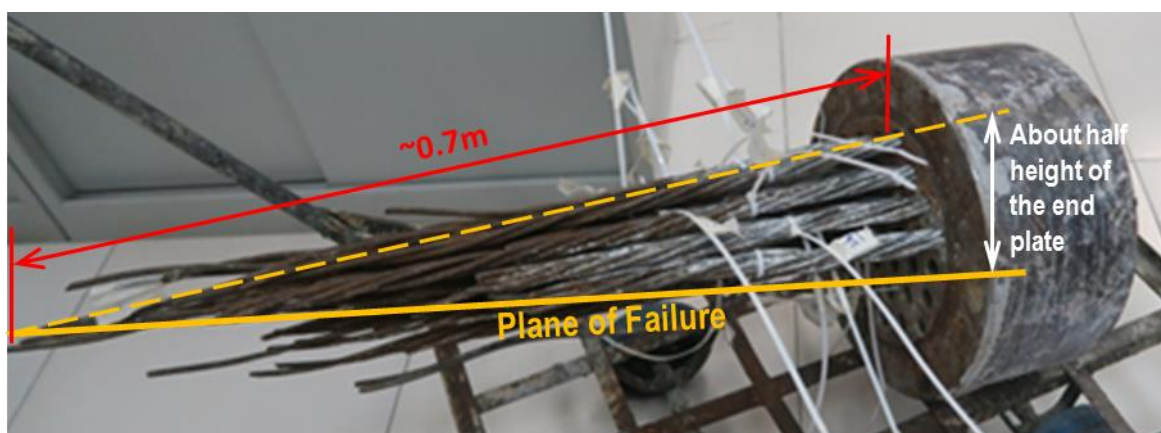

Figure 11 General view of broken strands at anchor head P5

- (ii) The steel strands at the upper half of anchor head P5 exhibited signs of serious corrosion with significant reduction in cross-section, and some of the fracture zones had corroded steel areas to the extent of forming

sharp end features. Twelve steel wires with serious corrosion were examined more thoroughly in SEM to characterise their nature of failure. Despite the serious corrosion, the fracture surfaces on all samples examined exhibited typical dimple features that are characteristics of ductile tensile overload failure. An analysis of the chemical species by an EDAX at the interface between the corroded surface and base metal also revealed no signs of any aggressive elements.



**Figure 12 Broken strands with significant reduction in cross section**

- (iii) The steel strands at the lower half of anchor head P5 did not reveal any significant sign of corrosion. The failure of these strands was mostly due to pulling out of wires from the anchor head with the surrounding wires ruptured due to ductile tensile overload failure.



**Figure 13 Ruptured wires pulled out from anchor head**

- (iv) The steel strands in between the upper and lower halves of anchor head P5 showed signs of slight to moderate corrosion. However, the corrosion appeared to be superficial and did not result in significant reduction of the cross-section of the wires. Most of the ruptured wires exhibited ductile tensile failure with cup-and-cone features. The final fracture surface of all wires yielded dimple features when examined at very high magnification using a SEM. The dimples are characteristic of ductile failure and indicate that corrosion had not caused any embrittlement of the wires. All tension failures of the strands were ductile in nature. No evidence of any shear type failure existed.



**Figure 14 Broken corroded wires with cup-and-cone failure feature**

- 3.1.3 White powdery paste (as shown in Figure 13), a product of grout bleeding, was observed at the end of tendon strands near anchor head P5 except the part of tendon strands subject to corrosion.
- 3.1.4 The Investigation Team also inspected the steel strands at anchor head P1. It was observed from the strands directly adjacent to the anchor block that the surfaces of the strands were all covered uniformly by whitish cementitious material and all the exposed strands basically exhibited no sign of corrosion.

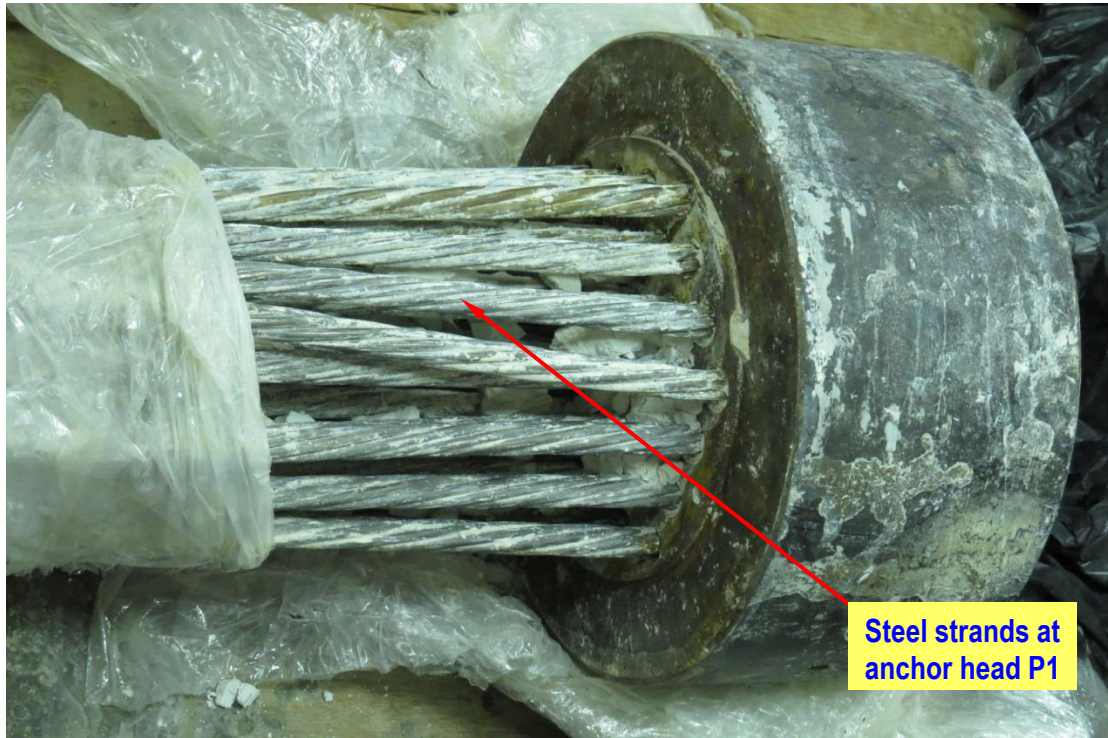

Figure 15 Condition of steel strands at anchor head P1 (with embedded grouts removed)

### ***Anchor Heads***

3.1.5 As shown in Figure 16, sign of rust was found at the upper half of the inner surface of the end plate at the anchor head P5, whereas the lower half of the inner surface contains some whitish powders of grout materials without any corrosion.

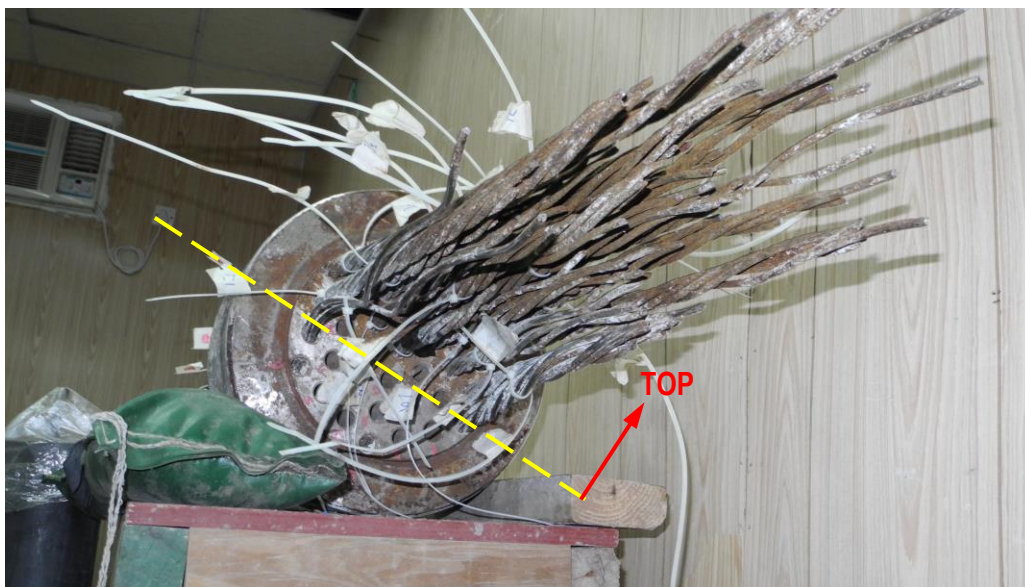

Figure 16 Condition of the inner surface of the end plate at anchor head P5

3.1.6 It is observed from the remains of the broken trumpet of anchor head P5 that a layer of residue had accumulated at the bottom of the trumpet. SEM analysis of the residue material revealed that the residue was basically a mix of dirt and iron powder, which was suspected to be left after the strand installation and stressing operation.



**Figure 17 Residue found at the bottom of trumpet at anchor head P5**

3.1.7 The wedges of anchor head P5 were found rendered with cement mortar to seal the wedge cavities while leaving a plastic tube (comprising two sections of tubes in difference sizes: the outer section connecting to the anchor protection cap is of 15mm outer diameter with 8mm inner diameter, and the inner section connecting through the end plate to the trumpet interior is of 8mm outer diameter with 5mm inner diameter) which was supposed to be an air release tube for expelling air trapped in the trumpet area during grouting.

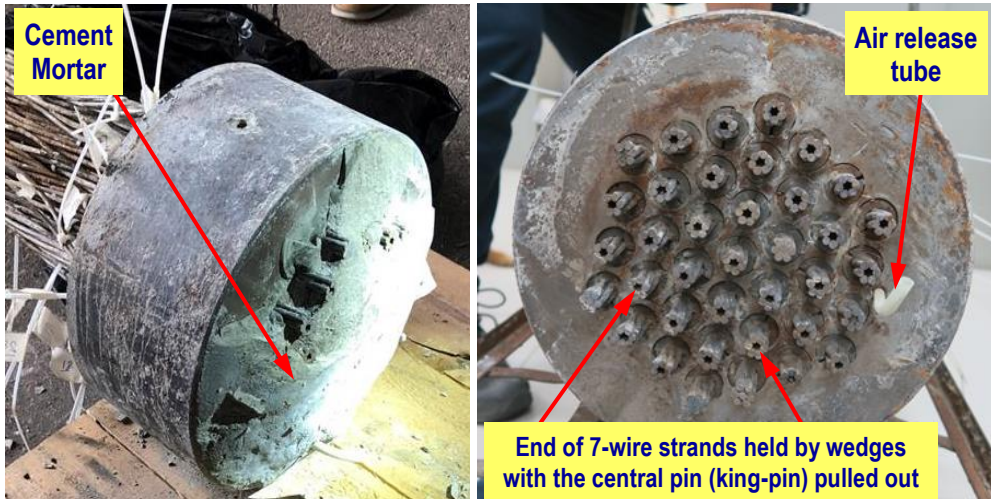

**Figure 18 (Left) Anchor head P5 rendered with cement mortar;  
(Right) P5 wedge area after removal of mortar with the air release tube exposed**

3.1.8 The Investigation Team further examined the air release tube at anchor head P5. It was observed that it was not filled with grout but traces of residue were observed inside the smaller tube. The residue inside the tube had a similar morphology to the grout at the interface of the air void and bleed-zone. This grout had clearly been effected with a high water/cement ratio from the bleed water and the possible residual water from the pressure test conducted on the duct prior to stressing of the tendon. The excess water would have accumulated at the head of the grout as the grout proceeded through the duct up into the trumpet area of the anchorage. SEM analysis revealed that this residue also contained dirt and iron powder identical to that found at the bottom of the trumpet.

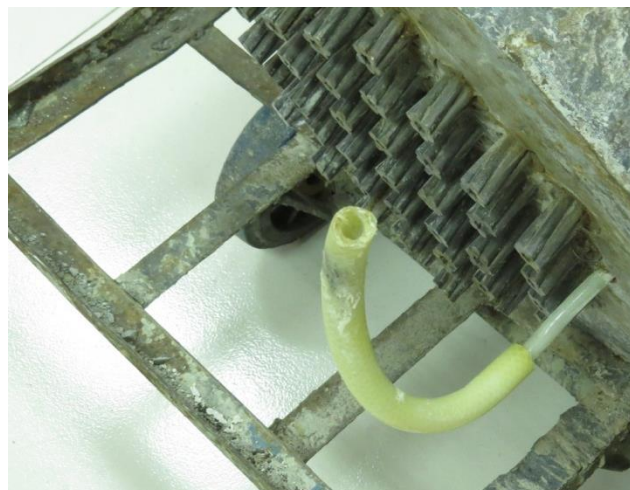

**Figure 19 Air release tube at anchor head P5**





**Figure 20 Trace of residue within air release tube at anchor head P5**

3.1.9 No sign of corrosion was found at the inner surface of anchor head P1 as shown in Figure 21. The wedges were also found in good condition to hold the steel strands firmly.

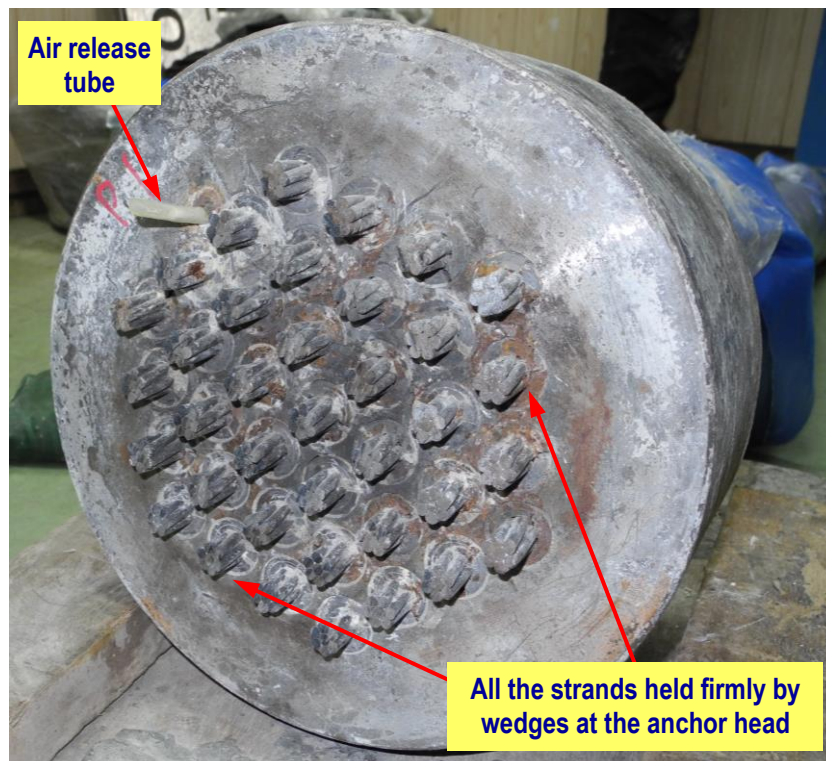

**Figure 21 Condition of wedges at anchor head P1**

3.1.10 An inspection to the air release tube at anchor head P1 revealed that it was partially filled with cementitious grout.



**Figure 22 Condition of the air release tube at the cap of anchor head P1**

### ***Grout Material***

- 3.1.11 According to the site records retrieved, the grout had been tested at the time of construction and confirmed to meet the specification requirements for strength and segregation.
- 3.1.12 The Investigation Team conducted chemical tests on grout samples collected at the ruptured tendon and the anchor heads. The test results showed that the chloride content satisfied the specification while the pH values were around 12 to 13.5, right within the standard values of cement. The test results did not indicate any sign of corrosion inducing element contained in the grout material.
- 3.1.13 Samples of grout material were also collected from different locations by the Investigation Team as shown in Figure 23 for examination in SEM. No abnormality was identified from the SEM analysis of the grout samples. Detailed results and analysis of the grout samples are presented in **Appendix A**.

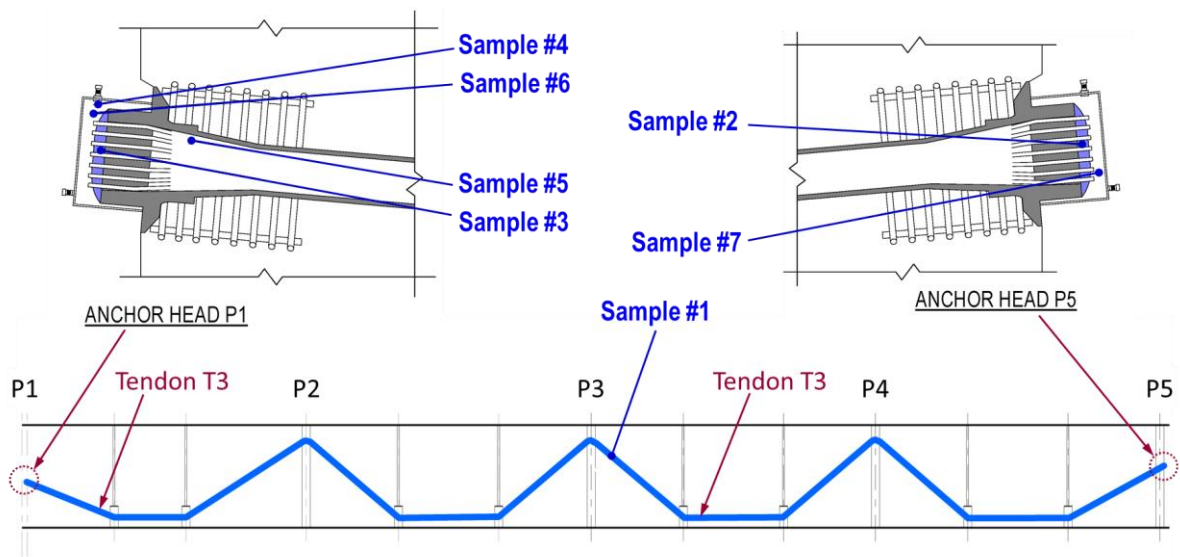

Figure 23 Locations of grout samples taken for SEM analysis

## **3.2 Structural Design**

- 3.2.1 The design of Bridge B2 was carried out by the consultant, Ove Arup & Partners Hong Kong Limited. It was designed as a single-cell trapezoidal box girder constructed by precast segmental method. The design covered the construction sequence and staging as well as the arrangement of prestressing tendons which comprised a combination of both internal and external prestressing tendons. The bridge was also designed to ensure that failure of either any two external prestressing tendons or of 25% of those at one section would not lead to collapse at the ultimate limit state under the design ultimate permanent loads.
- 3.2.2 The Investigation Team reviewed the design of the concrete viaduct of SBB-HK. It is noted that the design of the concrete viaduct of SBB-HK had been carried out in accordance with the relevant design standards and the design output had been duly reflected in the corresponding engineering drawings and specifications. The requirements of external prestressing, namely tendon details, prestressing forces, tendon profiles, and requirements on the sheaths were specified in the engineering drawings for construction. The design of the concrete viaduct was checked by an Independent Checking Engineer Gifford and Partners Limited in July 2003, appointed by the consultant. After the Incident, HyD's in-house staff conducted a check in April 2019 and reconfirmed that the allowable stresses in the box girder section were not exceeded under each staging. Upon reviewing the structural design of the bridge, the Investigation Team concurred that the incident had no significant impact on the structural integrity of the SBB-HK.
- 3.2.3 Following the contractual requirement, the specialist subcontractor proposed a prestressing system that satisfied the requirements specified in the engineering drawings and specifications. The particulars, including details of the prestressing system, calculated values of each type of loss of prestress, prestressing tendon forces and extensions of prestressing tendons and details of the method of measuring the extensions, were checked and approved by the consultant.

### 3.3 Construction Process

- 3.3.1 The Investigation Team examined and reviewed all available site records kept by HyD. Site records retrieved from Tuen Mun Government Records Management Office and HyD's maintenance depot at Shenzhen Bay Port dated back to 2002, including inspection forms for grouting works, site dairies, stressing reports and material test certificates relating to the tendon installation and grouting works were examined to identify any evidence of workmanship concerns on the tendon installation and grouting process as well as whether there was any non-compliance in material testing. Furthermore, the method statements and technical specifications for construction of external tendons were reviewed to locate any abnormalities during construction. However, the Investigation Team had not been able to retrieve the grouting and stressing reports for the concerned tendon.
- 3.3.2 A survey check by HyD Survey Team was also conducted to verify the tendon profile, including the position of the anchor heads and deviators of Tendon T3. The survey results concluded that the tendon and the anchor heads and deviators were all constructed according to the designed positions. No abnormality was observed.
- 3.3.3 The Investigation Team looked into the detailed installation sequence for external tendon T3 during the time of construction. Reference is made to the "Method Statement for External Prestressing Work" (Method Statement) dated 19 February 2004 at **Appendix B** with the stressing and grouting procedures for external tendons provided.
- 3.3.4 As the available site records did not reveal the locations of the grout injection point, the Investigation Team conducted detailed site inspection along the inner cell of Bridge B2 on the ruptured tendon T3 side and on the symmetrical parallel side of the deck with the same tendon arrangement with a view to obtaining further information to verify the installation and grouting sequence for the tendon concerned.
- 3.3.5 The Investigation Team also interviewed the VSL's staff to seek their advice on the location of the grout injection point for the Tendon T3 based on their knowledge and experience for similar grouting operations.

3.3.6 Based on the trace of grout injection points left on the other tendons and VSL's advice provided after a joint site inspection with the Investigation Team, the Investigation Team considered that the grout injection point for Tendon T3 was located at the low point in-between Piers P2 and P3. Such grout injection point was located at about 110m from anchor head P1 which is at about 170m from anchor head P5 (See Figure 24 below).

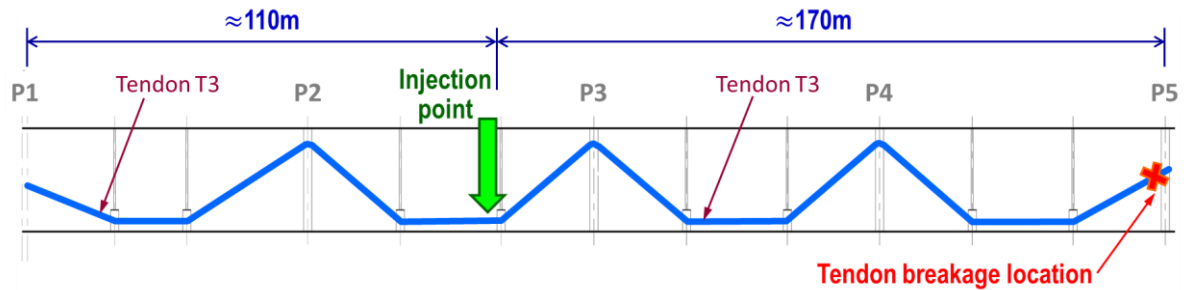

**Figure 24 (Left) Grout Injection Point observed on ruptured Tendon T3; (Right) Trace of grout injection points of tendons on symmetrical parallel side**

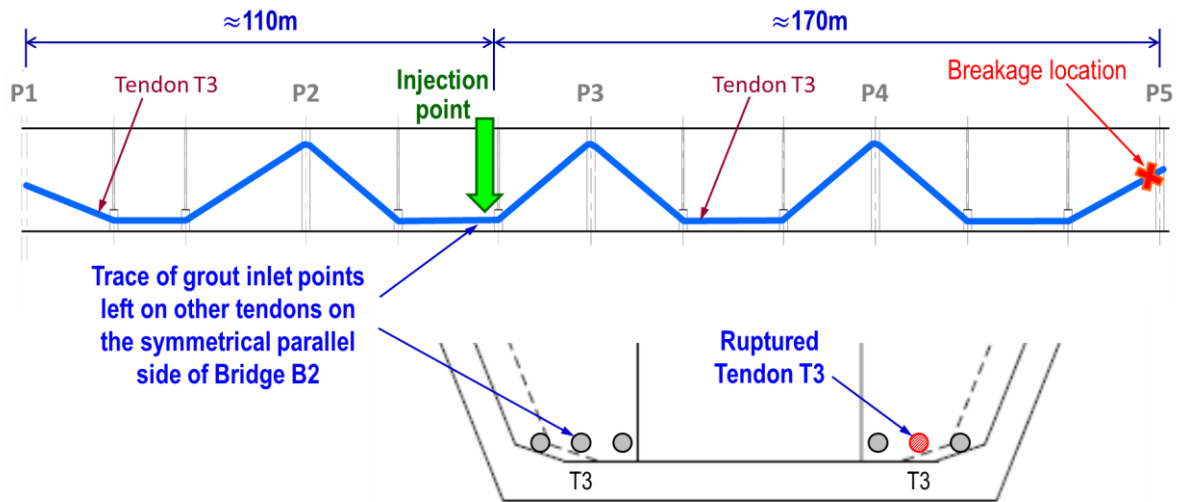

**Figure 25 Trace of grout Injection point at Tendon T3**

3.3.7 Based on the method statement and available information, the Investigation Team concluded that Tendon T3 and its anchor heads were constructed in the following manner.

- (i) Sequence 1 – After stressing of tendon T3, protruding strands outside the anchor block were trimmed and a small plastic tube was installed. The tube was not mentioned in the method statement. The Investigation Team considered that it should be an air release tube.

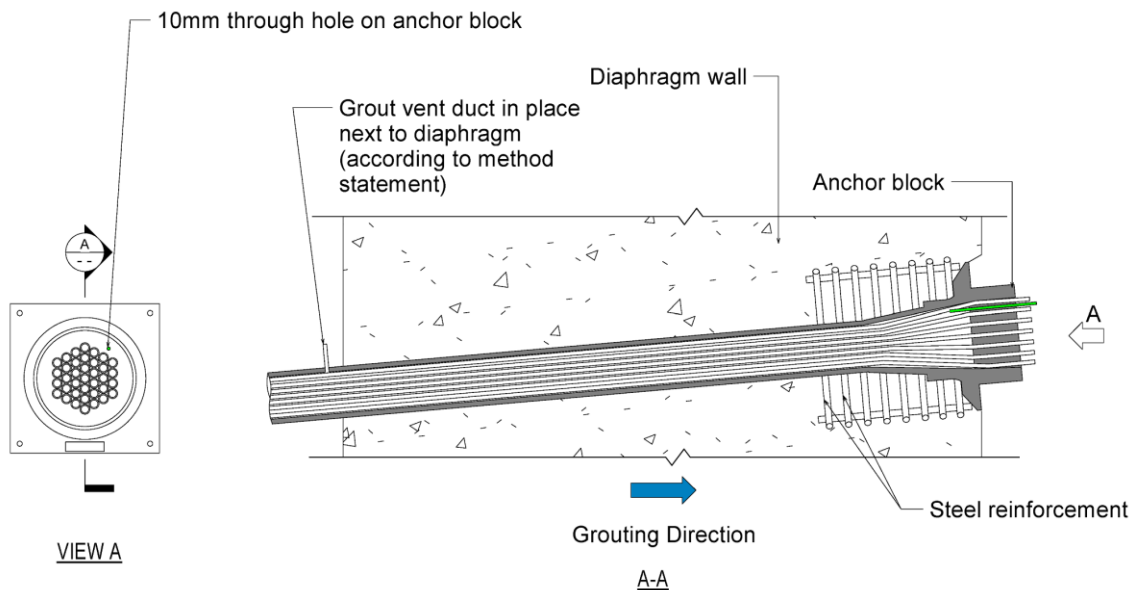

**Figure 26 Sequence 1 – Trimming of strands after stressing**

- (ii) Sequence 2 – The outer face of anchor head was patched with cement mortar to seal the wedges.

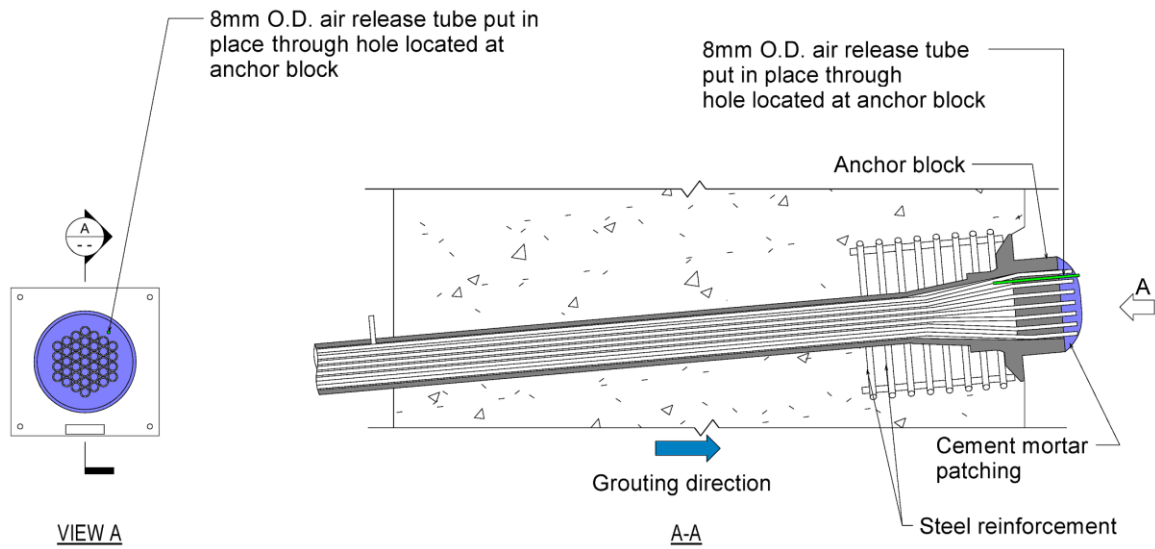

**Figure 27 Sequence 2 – Patching up anchor head outer face with cement mortar**

- (iii) Sequence 3 – Protection cap was installed at the anchor head, and the air release tube was extended to the top outlet of the protective cap.

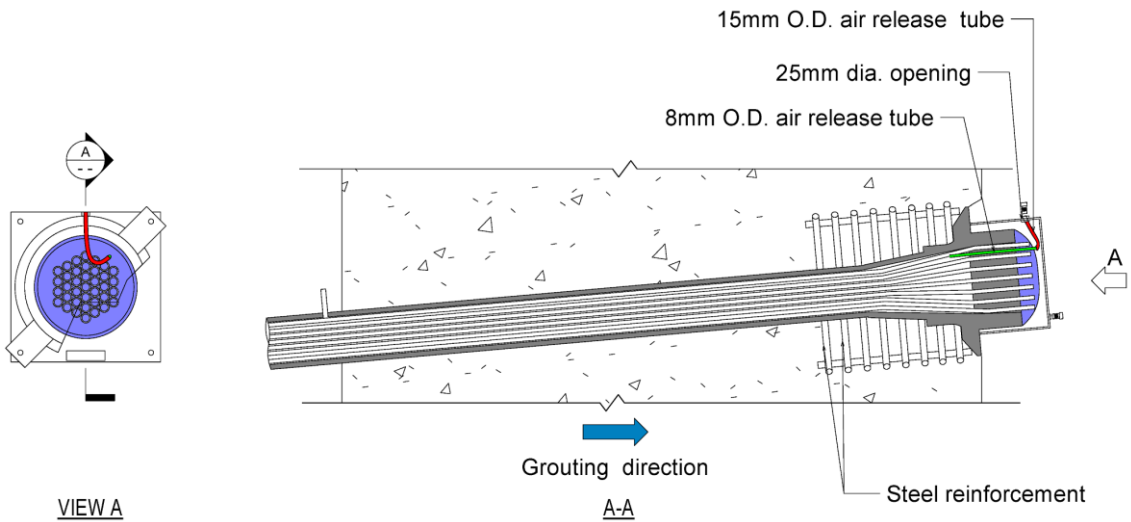

**Figure 28 Sequence 3 – Installation of anchor head cap**



- (iv) Sequence 4 – The tendon duct was filled up with water through the grout vents. The water test was conducted by maintaining a pressure of 0.5MPa to ensure no leakage throughout the system.

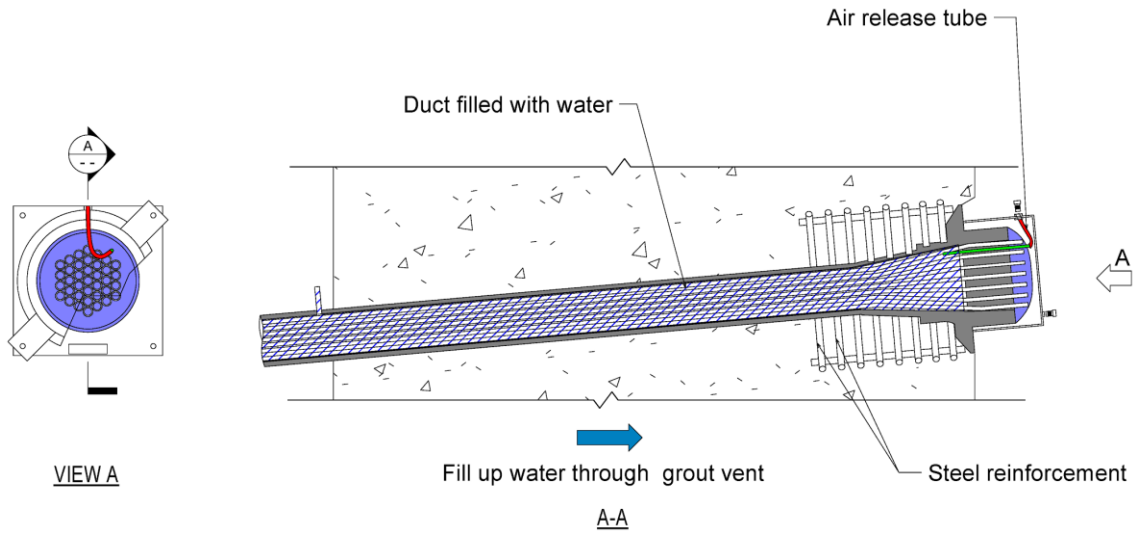

**Figure 29 Sequence 4 – Water test to ensure no leakage in duct**

- (v) Sequence 5 – All water in the duct was drained out from the lower outlet points after confirmation of no leakage detected in duct.

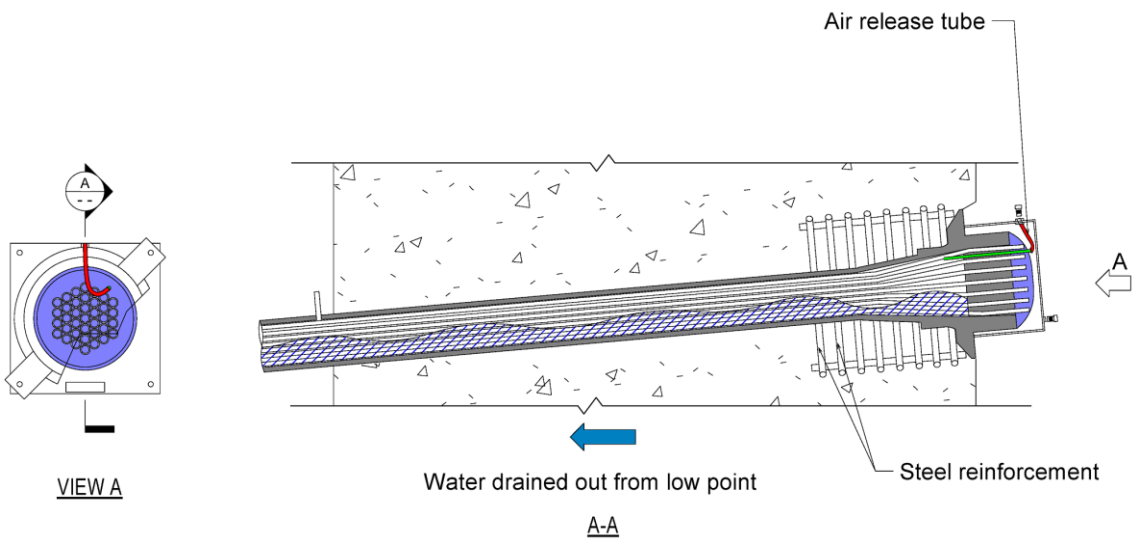

**Figure 30 Sequence 5 – Drain all water out after confirmation of no leakage in duct**

- (vi) Sequence 6 – Grout was pumped through the grout injection point at a low point in-between P2 and P3. It travelled along the duct through P3 and P4 towards P5.

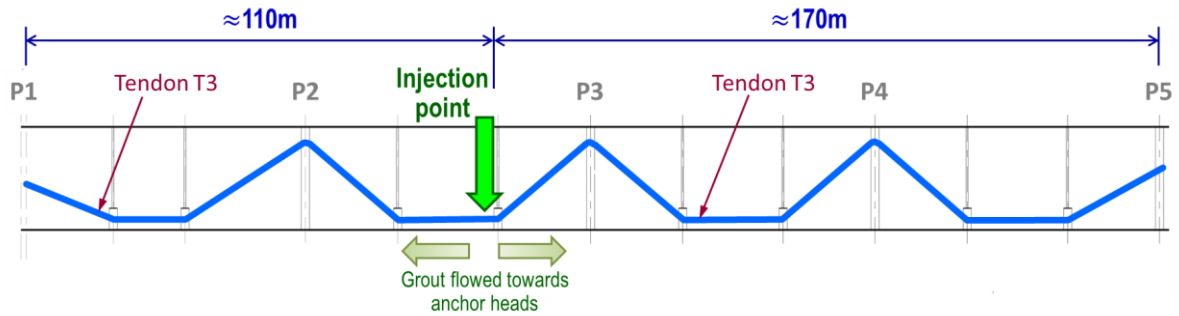

**Figure 31 Sequence 6 – Grout commenced from low point towards anchor head P5**

- (vii) Sequence 7 – Grout travelled along the tendon and grout pressure dropped gradually along the duct when approaching anchor head P5.

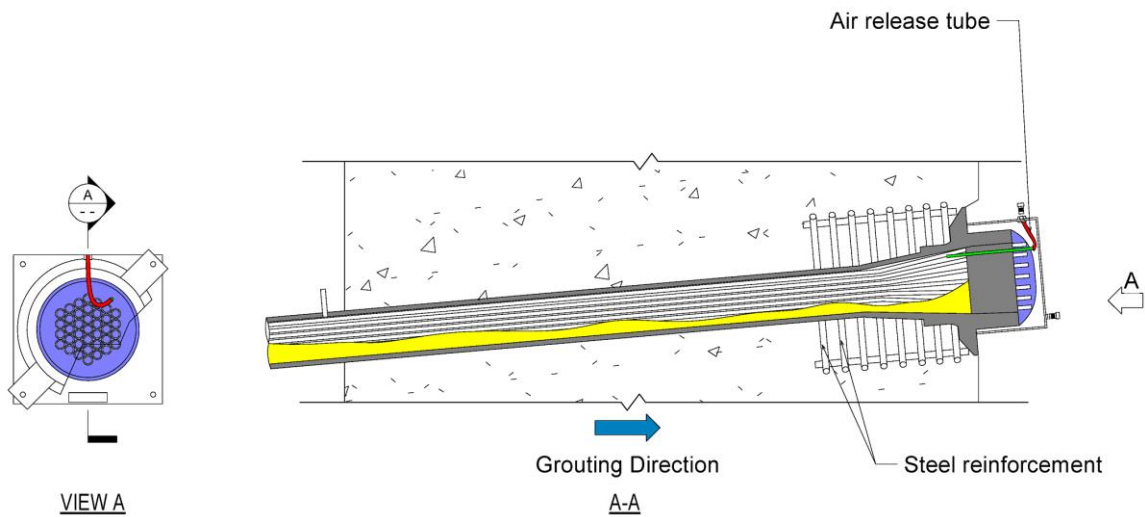

**Figure 32 Sequence 7 – Grout approached anchor head P5**

(viii) Sequence 8 (Expected Condition) – Grout filled up completely the anchor head area, and the grouting operation stopped.

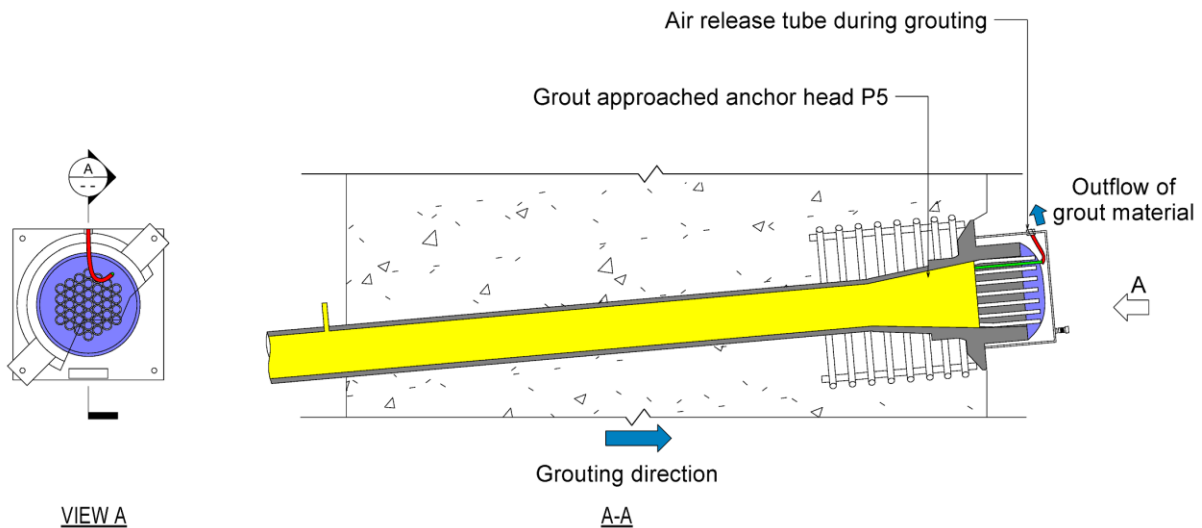

**Figure 33 Sequence 8 – Grouting operation within the tendon duct completed (Expected Condition)**

(ix) Sequence 9 (Expected Condition) – The protection cap of the anchor was subsequently filled up by grout under a separate operation.

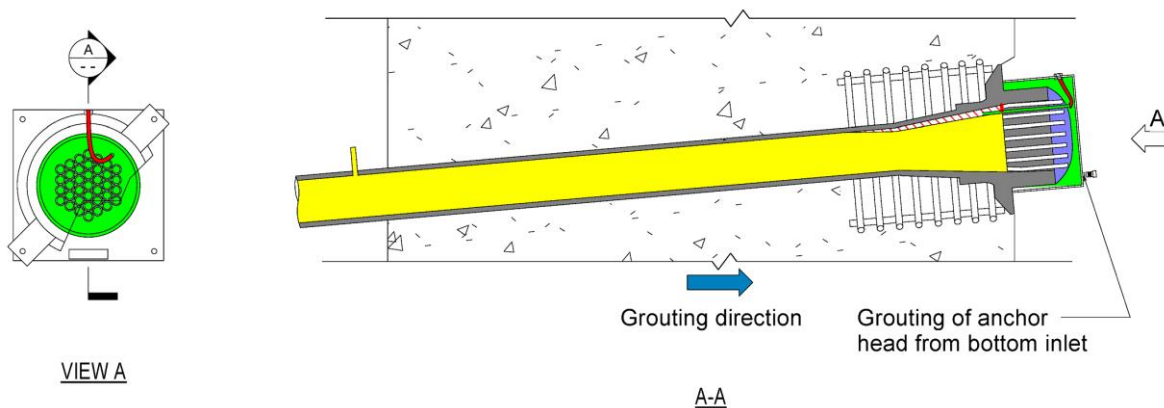

**Figure 34 Sequence 9 – Anchor protection cap subsequently filled up by grout under a separate operation (Expected Condition)**

3.3.8 According to the Method Statement, grout was pumped through the grout inlet from the lower end of the tendon until it expels out from the grout vents. Inspection should be carried out on the expelled grout to see if it is free from air bubble and in consistent with the grout as in the mixer, and a further 5 litres of grout should be discharged from each grout vent before closing of the vent. The grouting operation would stop when grout pressure in the

tendon with all grout vent closed off had been maintained at 0.5MPa or above for 5 minutes at the injection point.

3.3.9 However, it is evident from site inspections and material test results that the duct was not completely filled resulting in formation of an air pocket after the grouting operation. Figures 35 and 36 illustrate the estimated grouting situation of Tendon T3 according to the investigation findings.

- (i) Sequence 8A (Estimated Condition) – When the grout was approaching anchor head P5 with the surge, and the residue at the bottom of the trumpet was flushed up into the air release tube due to grout surge phenomenon.

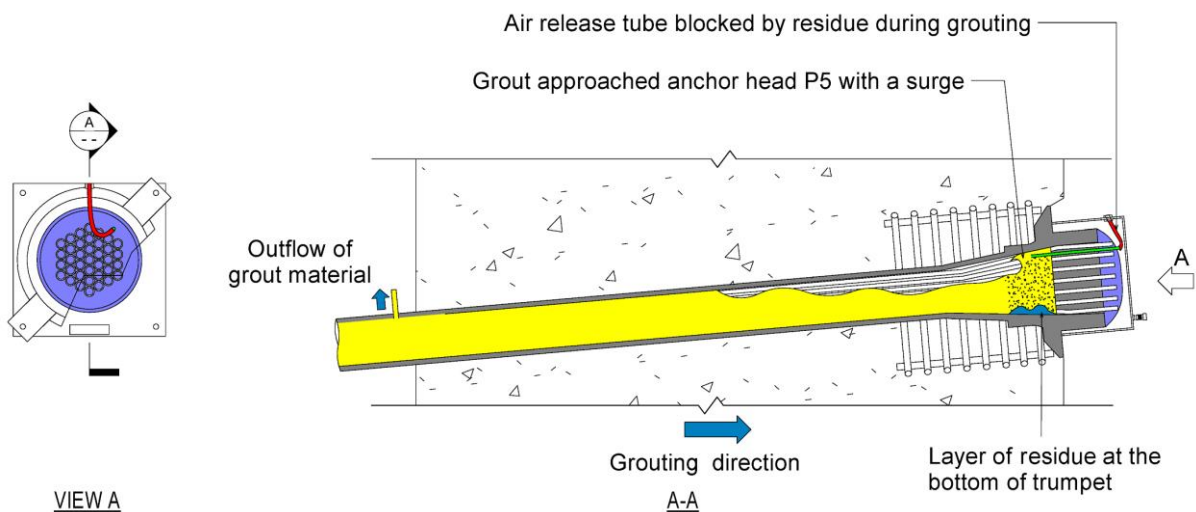

**Figure 35 Sequence 8A – Grout approached anchor head P5 with a surge (Estimated Condition)**

- (ii) Sequence 9A (Estimated Condition) – As indicated in paragraph 3.1.8, the air release tube was not filled with grout but trace of residue was observed inside the tube. The residue was considered to partially block the air release tube during the grouting process. As the nearest grout vent was located outside the diaphragm wall, the grouting operation stopped when the 5-litre of grout had been received at this grout vent while the air pocket at the trumpet area was yet to be filled. The protection cap of the anchor was subsequently filled up by grout under a separate operation.

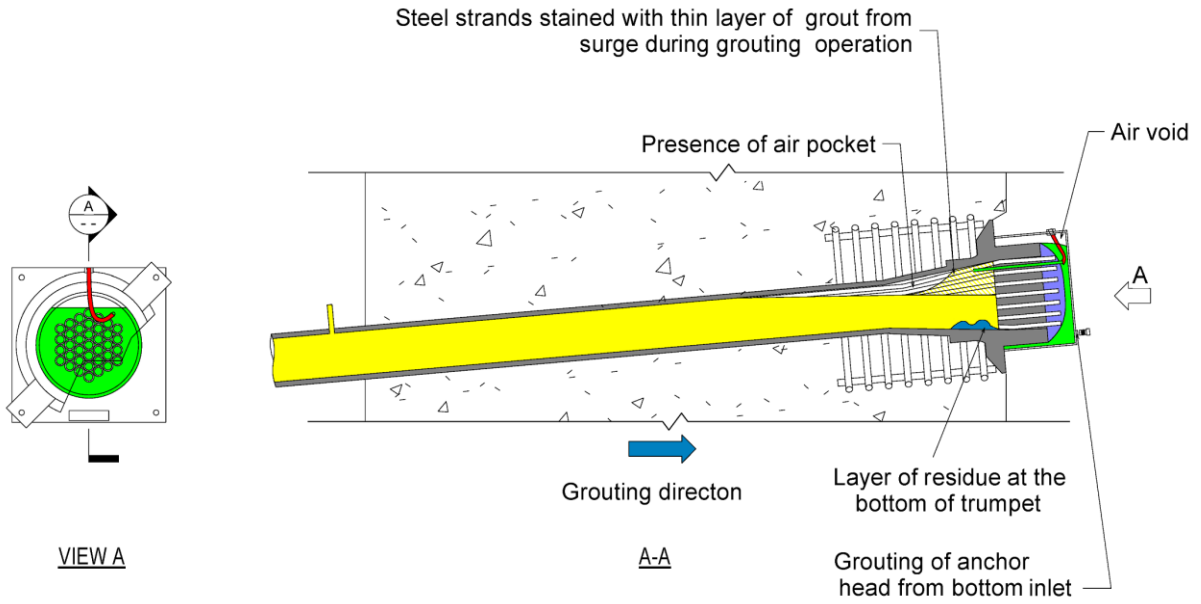

**Figure 36 Sequence 9A – Grouting operation stopped and anchor protection cap subsequently filled up by grout (Estimated Condition)**

### 3.4 Maintenance Arrangement

3.4.1 According to the Operation and Maintenance Manual of the SBB-HK, inspections of the bridge structure of SBB-HK are conducted by independent inspection consultants specialised in bridge inspection under the supervision of the HyD. The inspections are mainly divided into the following three types:

(i) Six-monthly safety inspection

This inspection primarily involves visual inspection of the condition of the deck facilities, the main structural components and ancillary components of the bridge to check if there is any noticeable damage requiring follow-up actions.

(ii) General inspection

This inspection involves comprehensive check of the condition of the main structures and ancillary components of the bridge via close visual inspection.

(iii) Principal inspection

Principal inspection is carried out at intervals generally not exceeding 5 years, but may be up to 10 years if no major defect is found during the six-monthly safety inspections and the general inspections. In addition to close visual inspection on the condition of the main structures and ancillary components, the inspection consultant also examines the hidden components of the bridge by removing the decorative cladding panels and covering materials. The principal inspection also covers certain detailed tests such as those on concrete carbonation, chloride content and adequacy of reinforcement cover, with a view to assessing the condition of the bridge.

3.4.2 In addition to the above three regular inspections, special inspection will be conducted if particular problems are identified during regular inspections or the bridge is found to have been affected by serious incidents such as fire, flooding or typhoons. This special inspection will ascertain the structural condition of the bridge.

3.4.3 The latest safety inspection, general inspection, principal inspection and special inspection conducted on Tendon T3 were completed on 7 September

2018, 6 October 2017, 28 February 2013 and 16 February 2019 respectively. It is noted that the Cross Boundary Maintenance Section of New Territories Region of HyD had followed the established inspection requirement. According to the maintenance and inspection records, no sign of distress was identified before the Incident.

## **4. CAUSES OF TENDON FAILURE**

### **4.1 Analysis of Tendon Failure**

- 4.1.1 As mentioned under paragraph 3.3.9, an air pocket was formed at anchor head P5 as shown in Figure 36 during the grouting process due to failure of releasing the air pocket through the air release tube before stopping the grouting process.
- 4.1.2 The Investigation Team also noted the total length of Tendon T3 to be approximately 280m in length, with a single grout injection point located at a low point for Tendon T3 between Piers P2 and P3. This grout injection point was located at about 170m from anchor head P5. The grouting operation requires that once the duct is filled with grout a pressure of 0.5 MPa be maintained for 5 minutes. However, long multi-span tendons with multiple curvature changes have a greater likelihood of gradual pressure head loss of the grout along the long duct under the grouting operation than shorter tendons with less curvature changes. Due to the head loss from the grout injection point progressively to the anchorage at P5, this pressure may have been gradually decreased along the duct. The reduced pressure coupled with the partial blockage of the air release tube further worsened the situation for releasing the air pocket at the trumpet area via the tube.
- 4.1.3 As indicated in Figure 37, with the inclination of the tendon profile and the anchorage at the high end point of the tendon T3 profile, a grout interface existed at a level approximately at the mid-height of the anchor through which the strands were held by the wedges. This interface between the top of the grout and the air pocket was a region where the bleed water from the grout accumulated.



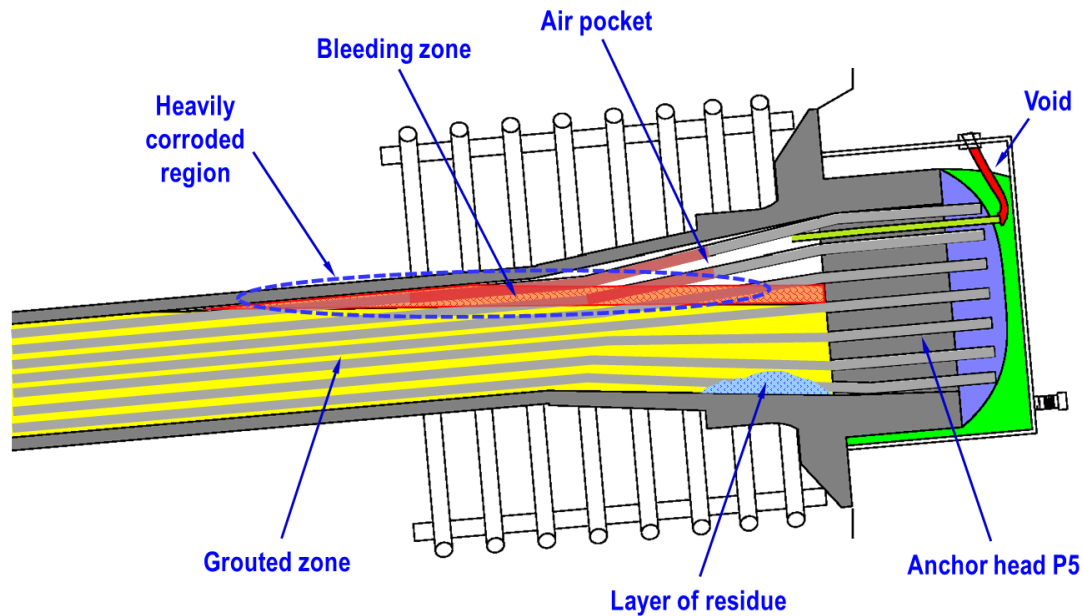

**Figure 37 Corrosion development on steel strands of tendon T3 near anchor head P5 at the voided region with free-water from bleeding and trapped air pocket**

4.1.4 Bleeding in cementitious grout is a common phenomenon in which free water in the mix rises up to the surface and forms a paste of weak cementitious material on the surface known as laitance<sup>3</sup>. Laitance without foreign material is alkaline in nature and not aggressive. Generally speaking, bleeding by itself will not cause harmful effect to the surrounding steel strands. However, the weakened cementitious material, as exhibited in white powdery paste, lost its homogeneity and became permeable and hence it could not protect the surrounding steel strands as designed for.

4.1.5 The free water generated by grout bleeding, or bleeding water, further accumulated in the confined space within the duct. This free water evaporated and condensed again within the space where steel strands without grouting protection were located. Corrosion then took place on these steel strands at the grout interface along an approximately horizontal plane, where moisture and air were present.

4.1.6 The corrosion of the strands caused a continuing decrease in the tendon area. Under the constant prestressing force, the stress in the tendon subsequently

<sup>3</sup> White powdery paste as observed at the surface of the remaining strands at anchor head P5 exhibited evidence of bleeding. Test of the white paste revealed that the material possessed a high pH value and was alkaline in nature. Tests of chloride content also revealed that the material had satisfied the requirements in the specification (<0.1%). The white powdery material is by itself not corrosive.

increased with the reducing cross-sectional area. This process of reducing cross-sectional area and increasing stress continued until the stress reached the ultimate tensile strength of the strands. When the strands had insufficient cross-sectional area to take the prestressing force, the tendon ruptured and caused the Tendon T3 to fail.

- 4.1.7 Such corrosion induced failure tended to be sudden since there was no means to gradually release the strain energy in the exterior tendon as corrosion of the tendon occurred. The tendon was not bonded to the structural concrete, and therefore had no restraint once failure occurred.
- 4.1.8 For the anchor head P1, the Investigation Team had inspected the air release tube and it was observed that the tube was partially filled up with cementitious grout. As for the condition of the anchor head P1, neither sign of air pocket nor corrosion of the steel strands was identified.
- 4.1.9 Unlike the situation at anchor head P5, the air release tube at anchor head P1 did not experience any blockage problem. It was considered that even there was slight blockage of the air release tube, the grout pressure at anchor head P1 was sufficient to push the trapped air away from the anchor head area through the tube, leaving no sign of air pocket. The anchor head P1 was located at about 110m away from the grout injection point, which was much closer than that of anchor head P5 which was about 170m from the grout injection point. The Investigation Team considered that for tendon with grouting length not exceeding about 100m, though there was still a gradual head loss along the tendon, the pressure head was sufficient to push the trapped air fully away. On the other hand, for tendon with grouting length over 100m, the gradual reduction in grout pressure along the tendon if coupled with any partial blockage of the air release tube by coincidence, there might be a likelihood that the pressure head was insufficient to expel the air from the trumpet area and leading to the formation of the air pocket. Without any air pocket formed at the anchor head area, the occurrence of the tendon failure as at anchor head P5 could be eliminated.

## 4.2 Concluded Causes of Tendon Failure

4.2.1 According to detailed investigation on the materials, site evidence, site records and method statements, the Investigation Team determined that the Incident was due to corrosion attack on the steel strand causing deterioration of their structural capacity. The weakening of the steel tendons due to corrosion resulted in the rupture of Tendon T3 at anchor head P5. The Investigation Team further considered that an air pocket was formed near anchor head P5 and provided the environment for the steel tendons to corrode.

4.2.2 Based on the investigation findings as detailed in Section 3 of this report, such air pocket was formed due to a couple of factors as listed below :

### 4.2.2.1 Partial blockage of the air release tube

It was evident that there were traces of residue inside the small air release tube attached through the anchor head. The residue material obstructing this tube was a mixture of dirt and iron powder material. The residue was suspected to be left and accumulated at the bottom of the trumpet during the insertion of the strands and water pressure testing. Such residue might be flushed up into the air release tube during grouting process and prevent the tube from functioning properly for expelling the trapped air at the trumpet area.

### 4.2.2.2 Long tendon length with deflected tendon profile

The Investigation Team identified that the total length of Tendon T3 to be approximately 280m long in length, with the grout injection point approximately 170m away from anchor head P5 (failed location). The pressure of grout might have dropped gradually along the tendon before reaching anchor head P5 which was located at a high point after the long distance through a deflected tendon profile.

4.2.3 Based on the completely different grouting condition at anchor heads P5 and P1, the Investigation Team considered that, for grout injection point located over 100m from the anchor head, the drop in grout pressure at the anchorage region if coupled with any partial blockage of the air release tube might be insufficient for expelling the air from the anchorage region. As mentioned in paragraph 4.2.2.1, this would worsen the situation and raise

the likelihood of forming an air pocket at the trumpet area causing corrosion problem. Since the grout injection point is located at an appropriate low point in the tendon which is often at approximately the mid-length of the tendon, the Investigation Team considered that external prestressing tendons with a tendon length exceeding 200m might have a higher risk of having air trapped in the anchor head area.

- 4.2.4 As a combined result of the above factors, an air pocket remained after the completion of the grouting operation leading to insufficient grout protective layer on the steel tendon strands to resist corrosion on these strands.

## 5. MEASURES TAKEN/ TO BE TAKEN AFTER THE INCIDENT

### 5.1 Short Term

5.1.1 Immediately after the Incident, HyD arranged the maintenance contractor and the consultant (Ove Arup & Partners Hong Kong Limited) to examine the structural integrity of the bridge structure and to arrange for replacement of the ruptured tendon T3. The following measures have been carried out :

- (i) The consultant confirmed that the design of the SBB-HK is in compliance with Structures Design Manual for Highways and Railways (SDMHR). All external tendons are replaceable without having to restrict traffic on the highway and allowance has been made for possible circumstance of removing one to two tendons.
- (ii) The consultant also confirmed that failure of either any two external tendons or 25% of those at one section, whichever has the more onerous effect, will not lead to collapse at the ultimate limit state under the design ultimate permanent loads.
- (iii) The maintenance contractor conducted immediate inspection of the SBB-HK and confirmed no other similar tendon failure along the whole length of the bridge structure.
- (iv) The maintenance contractor arranged to replace the ruptured tendon T3. The replacement work was completed on 14 March 2019 and all traffic on SBB resumed normal on 15 March 2019.
- (v) Inspection to other 21 existing highway bridges with external prestressing tendons was conducted and completed in end April 2019. No anomalies were identified on the inspected external prestressing tendons. A list of existing highway bridges with external prestressing tendons is shown in **Appendix C**.

5.1.2 Since the sign of blockage of air release tube at anchor heads could not be readily identified outside the anchor protection cap, the Investigation Team recommended inspecting all the external prestressing tendons of SBB-HK with a length exceeding 200m by removal of the protection cap to identify

any signs of incomplete grouting and presence of entrapped air pocket especially at the anchorage regions. Among the total of 192 external tendons at SBB-HK, 72 of them exceed 200m in length.

- 5.1.3 The Investigation Team recommended that borescope inspection, with removal of the protection cap, could be conducted through the air release tube opening on the end plate to inspect the condition of prestressing tendons at the trumpet area.
- 5.1.4 Other forms of currently available non-destructive tests (NDTs) like ultrasonic or guided wave testing have been considered for inspection of the tendons. As the anchor heads of all the tendons are located at thick and heavily reinforced concrete bridge diaphragm walls (normally in the range of 2m thick) due to the need to transfer the horizontal force from the tendons to the bridge, the reliability of these NDT methods within the trumpet area is questionable. The Investigation Team considered that it would be difficult for adopting these NDT methods to identify accurately the corrosion situation of the steel strands at this area.
- 5.1.5 In order to thoroughly inspect the condition at the anchor heads as mentioned in paragraph 5.1.2 above, HyD has commenced removing the anchor protection caps of all external prestressing tendons at SBB-HK with a tendon length exceeding 200m (total 71 tendons excluding Tendon T3) for detailed inspection by borescope.
- 5.1.6 HyD will also arrange to inspect the remaining 120 external prestressing tendons in detail by removal of anchor protection caps.
- 5.1.7 If any of the external prestressing tendons exhibits signs of defect in the above detailed inspection, appropriate remedial works including grouting of any air pockets identified, or under adverse situation, replacement of the defective tendons will be considered.

## 5.2 Medium to Long Term

- 5.2.1 To avoid occurrence of similar incidents in other bridges in Hong Kong with external prestressing tendons with similar characteristics, the Investigation Team recommended measures to inspect the conditions of these external tendons. The Investigation Team noted that vacuum assisted grouting method<sup>4</sup> has been widely adopted in the industry over the last decade. The method is believed to be an improvement to enhance grout filling process as it does not require to expel air from the anchorage region through any air release tube. There was also a change in the material specification for prestressing tendons in the General Specification for Civil Engineering Works<sup>5</sup> 2006 Edition as compared with its former version in the 1992 Edition. The material specification for grouting has been improved. All in all, these new methods are believed to have great improvement to the construction technique to overcome the aforesaid problems as identified in SBB-HK.
- 5.2.2 According to the records kept by HyD, for the other 21 existing highway bridges with external prestressing tendons in Hong Kong, a total of 626 external prestressing tendons have a length exceeding 200m. The Investigation Team recommended inspections be arranged progressively for some external prestressing tendons exceeding 200m long to ascertain whether there are any signs of incomplete grouting and presence of entrapped air pocket at the anchorage regions.
- 5.2.3 According to the investigation findings, the Investigation Team suggested that specifications and grouting design for prestressing should be reviewed. Based on the lesson learnt from the current incident in SBB, the Investigation Team recommends the following review in design, material, construction and maintenance of external tendons on highway bridges:

(i) Design

For the design of external prestressing system, the maximum length of the external tendon shall be one of the primary considerations for the

---

<sup>4</sup> Vacuum assisted grouting is a grouting process in which the injection of grout is assisted by vacuum so that any trapped air or cavity could be absorbed

<sup>5</sup> The General Specification for Civil Engineering Works lays down the quality of materials, the standards of workmanship, the testing methods and the acceptance criteria for civil engineering works undertaken for the Government of the Hong Kong Special Administrative Region.

bridge designers. Long external prestressing tendon with a deflected tendon profile might make the grouting works risky if coupled with probable blockage of air release tube at anchor head area. The bridge designers should consider if circumstance allows, adoption of a shorter length of tendon preferably not exceeding 200m for external prestressing tendons. The bridge designers should also consider measures to facilitate the routine inspection, maintenance arrangement including possible replacement for the tendon designed.

(ii) Construction

Regarding the current construction practice, Section 17 of the General Specification for Civil Engineering Works 2006 Edition specifies the material requirements and testing, installation and stressing operation for prestressed concrete. In view of the fact that significant advancement and changes of practice have been taken place in the general areas of external prestressing and grouting, it is suggested that a possible review of this section may be of benefit in ensuring that the best practice and material in prestressing concrete, such as the use of vacuum assisted technology, can be more widely adopted in the industry.

(iii) Maintenance and Inspection

Proper maintenance and regular inspection is always beneficial and critical to upkeep the performance of the external prestressing tendons. In view of the recent advancement of technology, introduction of intelligent monitoring system for the external prestressing tendons including wireless sensing and notification measures would be further explored and adopted where practicably viable.



## 6. CONCLUSIONS

- 6.1 The cause of the prestressing tendon failure at concrete viaduct of Shenzhen Bay Bridge (Hong Kong Section) was due to a combination of factors including the probable partial blockage of the plastic air release tube at anchor head P5 during the grouting operation, coupled with a gradually reduced grouting pressure along the long grouting length, leading to the presence of an air pocket at the anchorage region and subsequently causing corrosion of the steel strands in that area. The reduction in sectional area thus load carrying capacity of the steel strands due to corrosion resulted in the rupture of the tendon near anchor head P5.
- 6.2 According to the method statement, grout was injected at the low point of the tendon duct at about 170m from anchor head P5 and 110m from anchor head P1. The pressure applied was about 0.5MPa. Owing to the gradual head loss over the tendon length and the fluctuating up and down profile of tendon and the presence of the congested strands within the HDPE duct, head loss took place progressively. The grout pressure at anchor head P5 might not be sufficient to expel all the trapped air through the partially blocked air release tube during the grouting process.
- 6.3 The Investigation Team considered that the grouting length should be controlled within 100m (i.e. the tendon length should not exceed 200m) if vacuum assisted grouting is not adopted. Grouting length exceeding this limit coupled with any partial blockage of the air release tube at the anchor head might have a higher risk of leading to insufficient grouting pressure for fully release of the trapped air via the air release tube to fill up the entire volume of the duct with grout.
- 6.4 In this Incident, it was considered that an air pocket remained in the anchorage region as the process of grouting had been stopped prior to the complete filling of the duct in the anchorage region immediately behind the anchor head. With the inclination of the tendon profile and the anchorage at the local high point of the tendon T3 profile, a grout interface existed at a level approximately at the mid-height of the anchor through which the strands were held by the wedges. This interface between the top of the grout and the air pocket was a region where the bleeding water from the grout accumulated. This interface, in the presence of segregated grout, the

accumulated moisture and air, created an environment and potential for corrosion along an approximately horizontal plane. The combination of air and water corroded the steel strands causing the rupture of the Tendon T3.

- 6.5 In view of the Incident, various short, medium to long term measures have been proposed for phased implementation. It is considered that further enhancement to the design, construction and maintenance aspects of external prestressing tendons should be explored.

**Appendix A –  
Material Test Results**

### Summary of Material Tests and Results

Test	Sample	Scope of Test	Testing Laboratory	Testing Results
<b>Tensile Test</b>	6 nos. of steel strands	Determination of dimensions, mass per unit length and tensile properties of 7-wire strands in accordance with BS5896:1980.	Public Works Central Lab	Breaking load results comply with the Particular Specification of the SBB-HK project, ductile failure. ( > 279 kN )
<b>SEM &amp; EDAX Analysis</b>	12 nos. of rusted steel wires	(i) Characterization of the fracture morphology of individual wires by using magnification to identify signs of stress corrosion cracking  (ii) Determination of signs of foreign chemical species by using Energy Dispersive X-Ray Analysis (EDAX)	HKPC	No signs of stress corrosion cracking, ductile failure at breakage.
<b>Chloride Test</b>	6 sets of grout remnants	Determination of chloride content (Test No. CHM 5.3 of the Public Works Central Lab)	Public Works Central Lab	Tested chloride content comply with the Particular Specification of the SBB-HK project. ( < 0.1% )
<b>pH Test</b>	3 sets of grout remnants and white paste	Determination of pH values of grout samples and white paste around rusted wire and intact strands.	HKUST	The values are right within the standard values of cement. (12 – 13.5)
<b>SEM &amp; ICP-OES Analysis</b>	7 sets of grout remnants and white paste	Determination of the chemical composition to differentiate the chemical composition of the grout material at different locations.	HKPC	Samples at P1 & P5 anchor faces contain large Si particles, likely sand in mortar. Samples in trumpets & end caps exhibit signs of bleeding. Sample in intact tendon gives no sign of bleeding.

**I. Tensile Test Report of Steel Strands**

<b>Lab. Specimen No.</b>	<b>A01</b>	<b>A02</b>	<b>A03</b>	<b>A04</b>	<b>A05</b>	<b>A06</b>
<b>Measured Diameter (mm)</b>	15.8	15.7	15.7	15.7	15.7	15.8
<b>Cross sectional area (mm<sup>2</sup>)</b>	152	151	151	151	151	151
<b>Mass (g/m)</b>	1190	1182	1183	1183	1189	1184
<b>Breaking Load (kN)</b>	296	296	295	295	296	295
<b>Constriction at break</b>	Ductile	Ductile	Ductile	Ductile	Ductile	Ductile

## II. Analysis of Rusted Steel Wires

12 randomly selected wires with serious corrosion attack were examined more carefully in a Scanning Electron Microscope (SEM) to characterise their nature of failure. Despite the serious corrosion attack, the fracture surfaces on all samples examined exhibited typical dimple features that are characteristics of ductile overload failure with no signs of stress corrosion cracking. An analysis of the chemical species by an Energy Dispersive X-Ray Spectroscopy technique (EDAX) at the interface between the corroded surface and base metal also revealed no signs of any aggressive elements. Only traces of Chloride were found on one out of more than 30 points that were analysed and this was likely due to contamination to the sample after it was removed from the site.

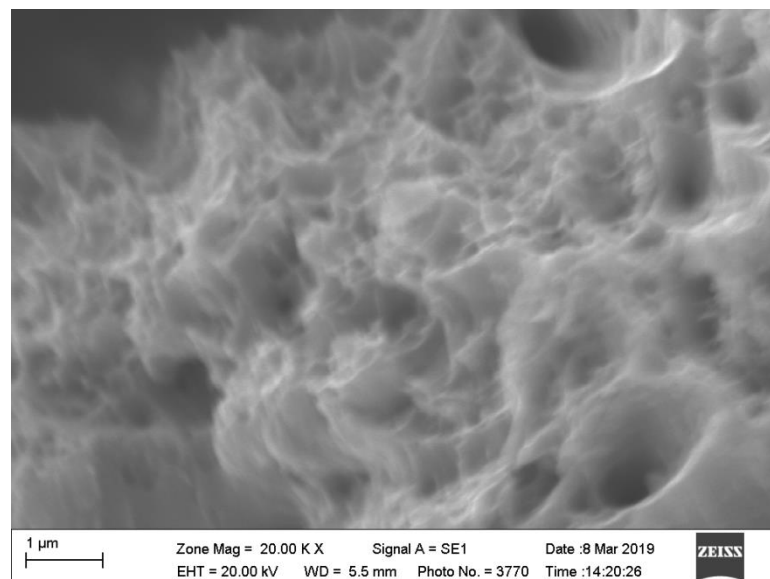
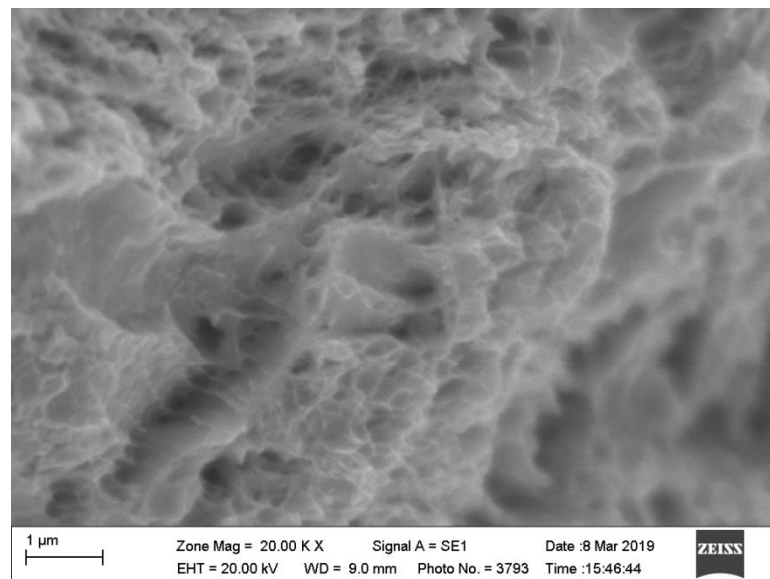

### III. Analysis of Grout

Samples of Grout removed from various locations were examined to determine the nature of the grout in service. The samples were cut into small sections and a surface polished and coated with gold to allow proper examination in a SEM. Detailed results and analysis of the grout samples are summarised as below:

Sample No.	#1	#2	#3	#4	#5	#6	#7
Location	Tendon Section SB37	P5 Anchor Body	P1 Anchor Body	P1 End Cap Top	P1 Trumpet	P1 End Cap	P5 End Cap
SEM Results	Normal Grout	Cement Mortar	Cement Mortar	Whitish Powder	Grout with Bleeding	Normal Grout	Normal Grout

**Sample 1:** Grout sample from a section at SB37 where no signs of corrosion of the tendons were found (This sample is treated as the control sample).

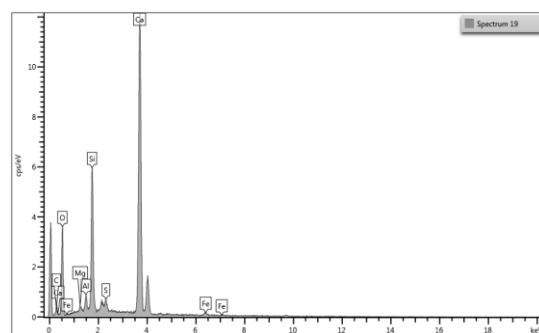
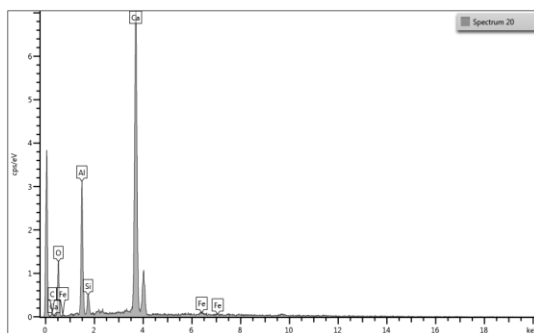
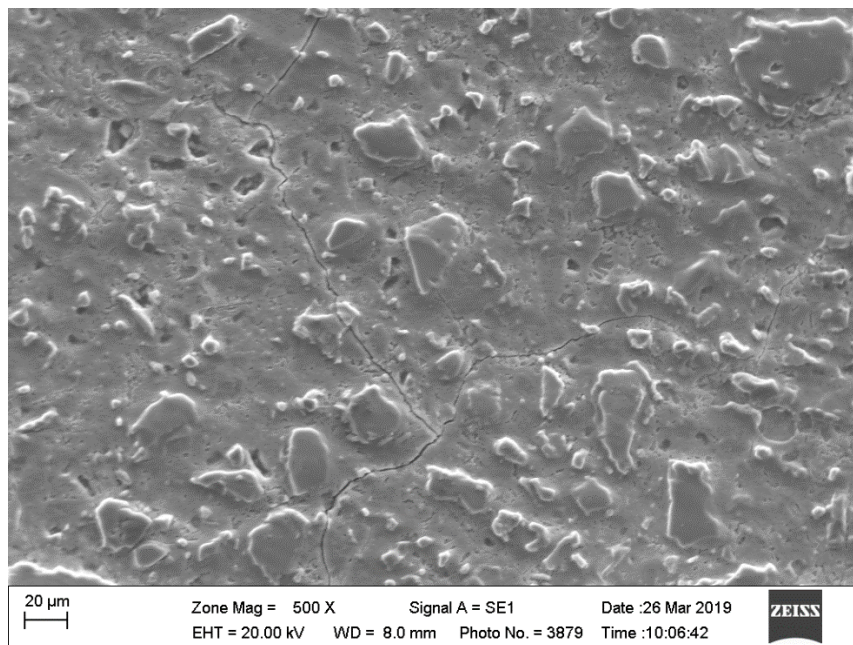

**Sample #2:** Sample from the end cap at P5, retrieved from the anchor body  
 A piece of sample from P5 Cap shows very different structure. This contained very large particles that are likely constituent of cement mortar. The matrix was simply Calcium rich cementitious material (Spectrum 30 & 31) and the large particles sands in the mortar.

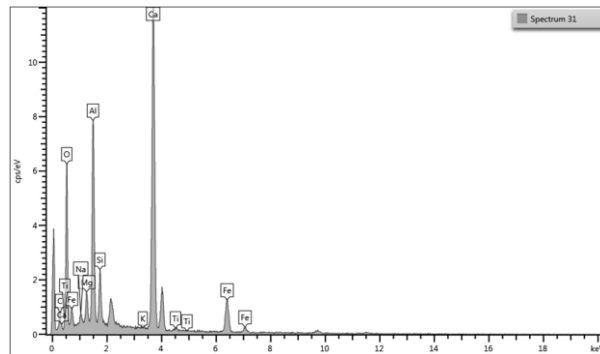
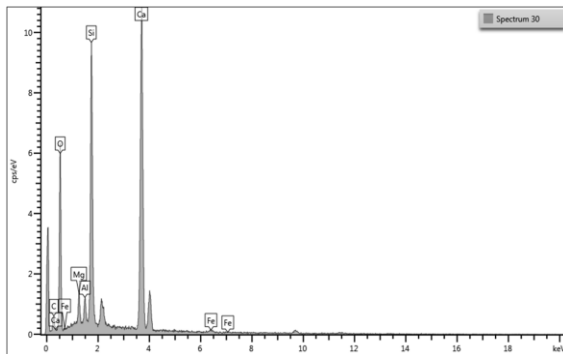
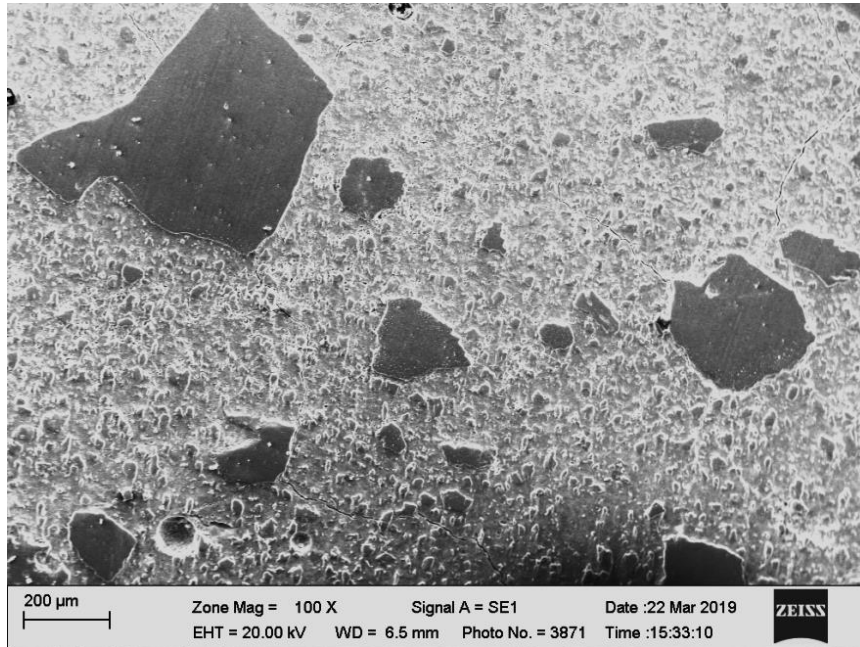



**Sample #3:** Sample from the end cap at P1, retrieved from the anchor body  
 This sample has a structure very different to the grout, and is similar to the mortar sample retrieved from the end cap of P5. The matrix was simply Calcium rich cementitious material (Spectrum 27 & 28) and the large particles sands in the mortar.

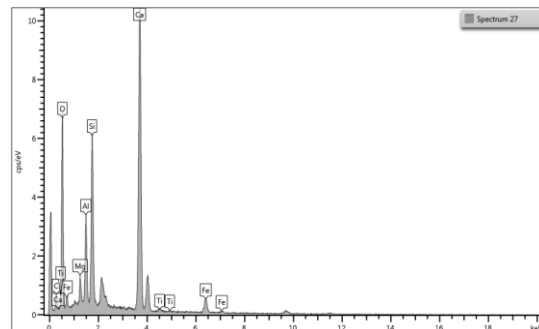
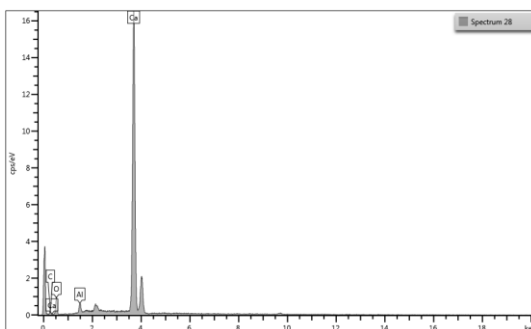
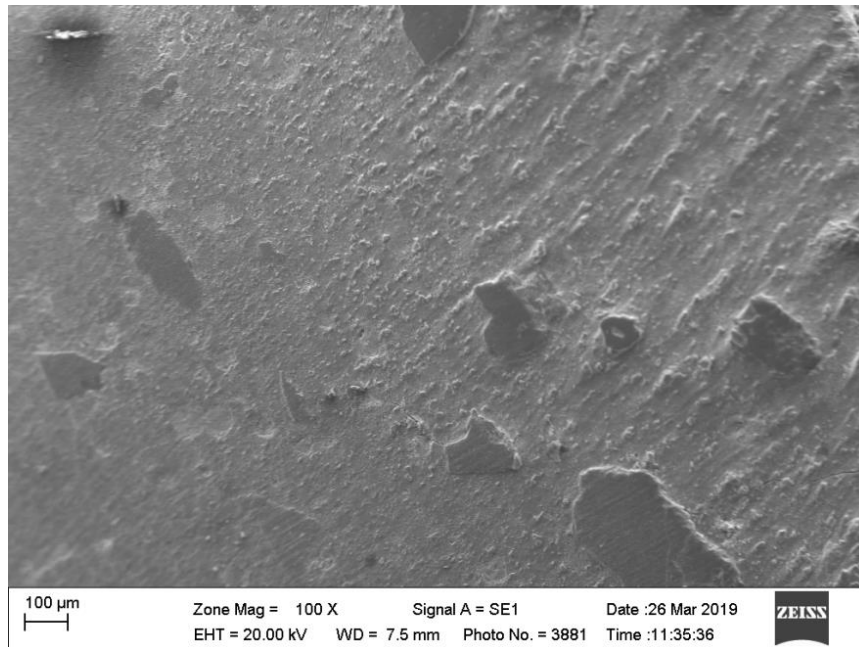

This confirmed that there was a layer of cement mortar attached to the anchor inside the end cap.

**Sample #4:** Taping of the whitish powders from the top of the End Cap of P1  
 The powders are Ca-S rich materials that are most certainly the products of bleeding which is known as laitance. No traces of Chloride were detected.

Electron Image 1

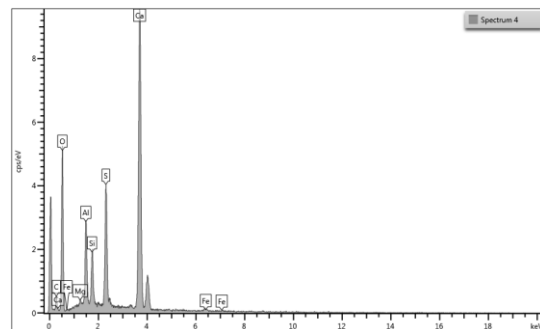
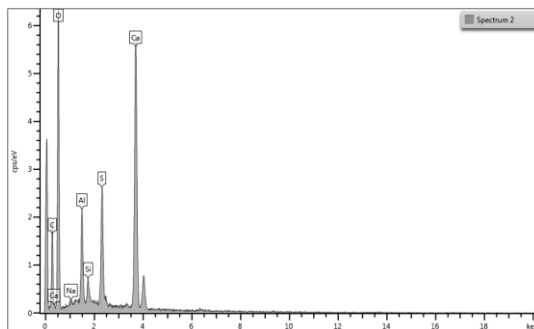
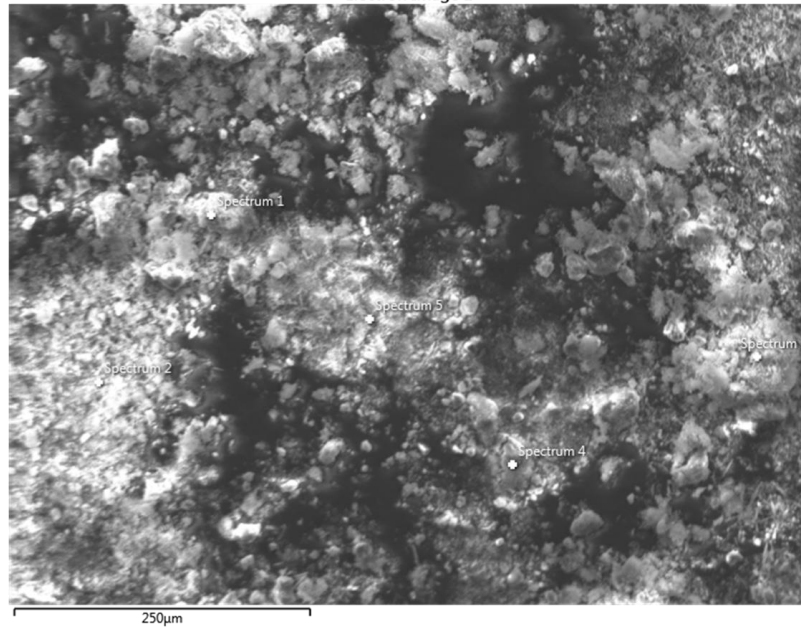

**Sample #5:** Grout Sample from the top of the End Cap of P1

An assessment was conducted along the section from the top into a block of sample, and the structure was found to vary through the thickness, from laitance (white powder), into a structure that contained a lot of white curly structure (Spectrum 64) and then into a structure of more consistent grout (Spectrum 63). The white curly structure is likely formed after bleeding.

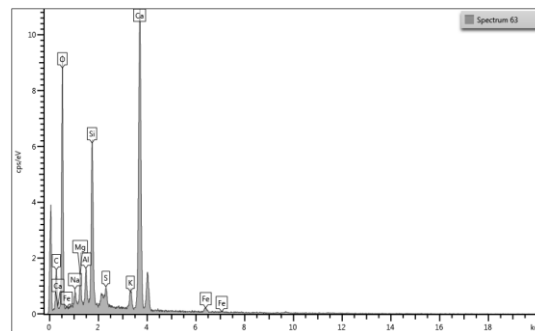
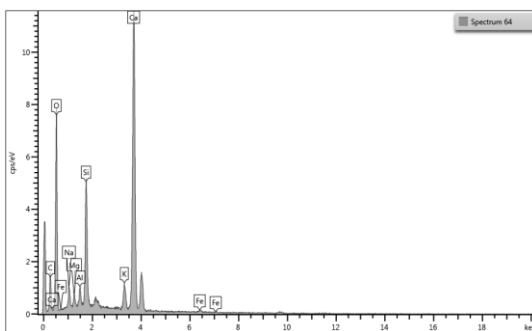
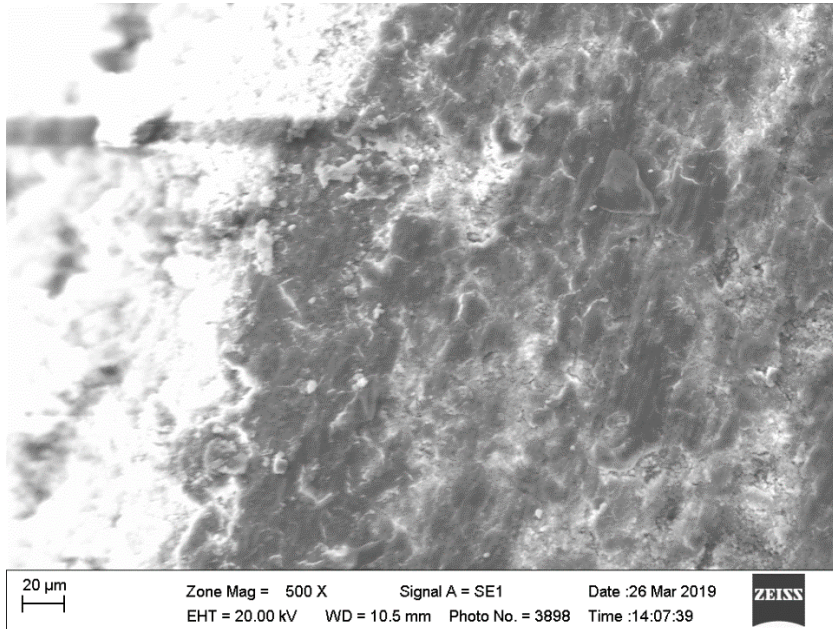

**Sample #6:** Grout sample from inside the end cap of P1

Similar to the structure of the control sample, likely to be normal grout but the Mg content appeared to be higher in the grout.

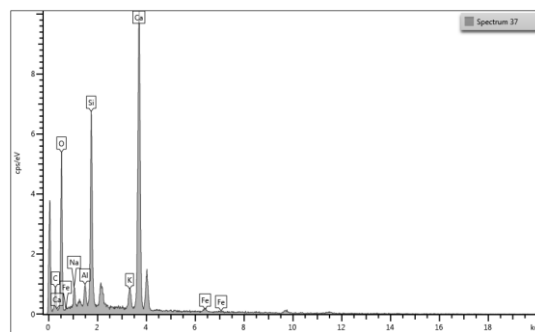
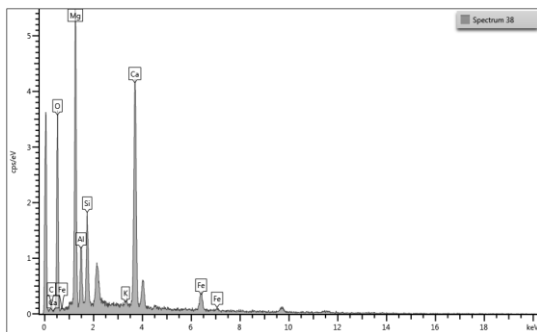
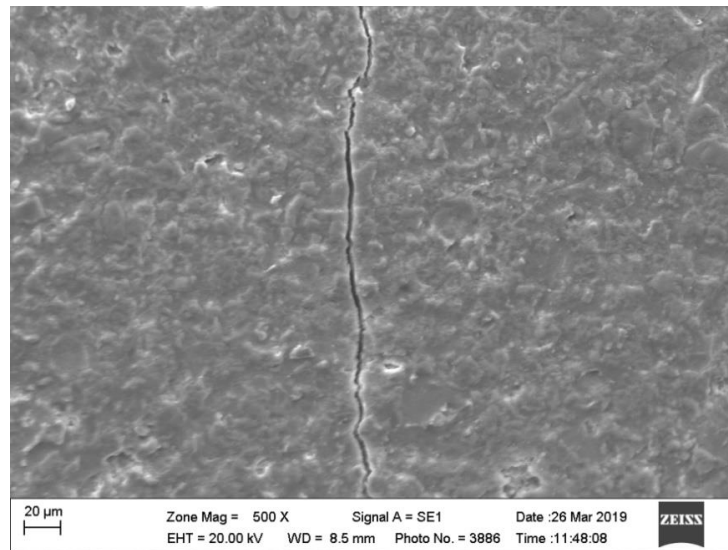

**Sample #7:** Grout sample from inside the end cap of failed end at P5

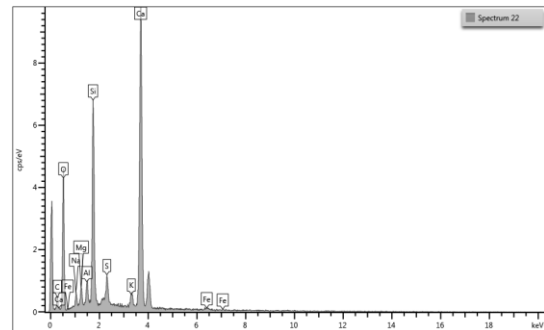
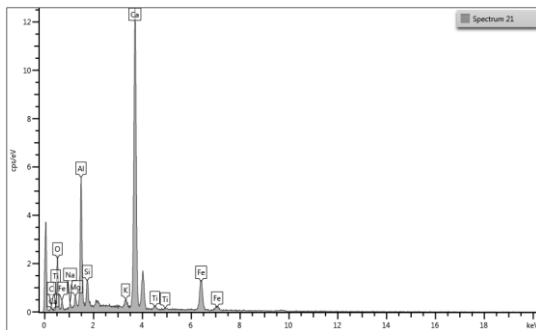
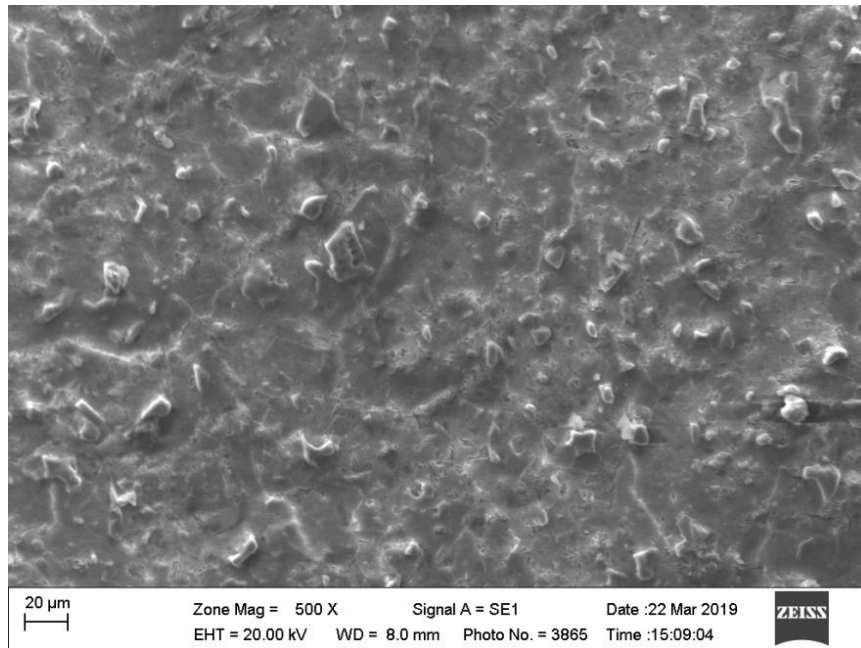

Similar to the structure of the control sample, likely to be normal grout, with limited or no signs of bleeding.

**Appendix B –**  
**Method Statement for External Prestressing Work**



SHENZHEN WESTERN CORRIDOR

CONTRACT HY/2002/21

FILE NO. Acc. M77.10.



004731 KKL

TRANSMITTAL LETTER

HY 2002/21  
SWC  
11 FEB 2004  
RECEIVED

To:	GAMMON SKANSKA LTD - SKANSKA - MBEC	Ref. :	TL/0042
Attention to:	Messrs. A. Rooney / W. K. Lau	Date:	10-Feb-04
Subject:	Method statement for external prestressing works	Copy to:	PBU (w/o. encl) HCH, KML A.Lin (VSLHK)

We are sending you the following	<input checked="" type="checkbox"/> Herewith	<input type="checkbox"/> As per your request	<input type="checkbox"/>
	<input type="checkbox"/> Drawings	<input type="checkbox"/> Shop drawings	<input type="checkbox"/>
	<input type="checkbox"/> Samples	<input type="checkbox"/> Products	<input type="checkbox"/>
	<input checked="" type="checkbox"/> Method statement	<input type="checkbox"/> Equipment	<input type="checkbox"/> RFI

For your	<input checked="" type="radio"/> Approval	<input type="radio"/> Record / File	<input type="radio"/> Information
	<input type="radio"/> Review & Comment	<input type="radio"/> Action	<input type="radio"/>

Reference/No	Rev.	Format	Description
GSL/SWC/VSL/3/00/002	0	P.1 to 73	Method statement for external prestressing work

Notes:  
Please also find enclosed 3 VSL PT brochure for your information

Issued by: VSL-SWC 

Please acknowledge receipt by signing below and returning a copy of this page to VSL.	Date:	Receipt acknowledge by:

12939 (HK-SWC) Metric Section		
Name	Initial	Date
WKL		
HL		
AL		
WKL		
WKL		
JL		
JL		
ST		
ZCM		



<b>Contractor</b> 		<b>Project</b> <b>CONTRACT NO. HY/2002/21</b> <b>Hong Kong - Shenzhen</b> <b>Western Corridor</b>		<b>Consultant</b> <b>Appendix B</b> <b>ARUP</b> Ove Arup & Partners Hong Kong Limited	
--	--	--	--	--	--

**CONTROLLED COPY 51**

0	2 Feb 04	First Issue	ANDY
Rev	Date	Description	Prepared



**VSL SWC**  
51/F, Hopewell Centre,  
183, Queen's Road East, Wanchai, Hong Kong  
Tel: (852) 2590 2288 Fax: (852) 2590 0290

**TITLE**

**METHOD STATEMENT  
FOR EXTERNAL PRESTRESSING WORK**

**DOCUMENT NO.:**

**GSL/SWC/VSL/3/00/002 rev.0**

Prepared <b>ANDY</b>		Checked <b>HCH</b>		Approved <b>PBU</b>	
Date <b>04 Feb. 04</b>		Date <b>04 Feb. 04</b>		Date <b>04 Feb. 04</b>	
Signed <i>Andyk</i>		Signed <i>HCH</i>		Signed <i>PBU</i>	
<b>Production Manager</b>	<b>Quality Manager</b>	<b>Safety Manager</b>	<b>Project Manager</b>		
Date	Date	Date	Date		
Signed	Signed	Signed	Signed <i>AR</i>		

© Copyright Reserved  
This document is the property of VSL SWC and must not be copied, reproduced, duplicated nor disclosed totally or partially to any Third Party, nor used in any manner whatsoever without prior written consent of VSL SWC.

## Table of Content

<b>1</b>	<b>Scope of works and purpose</b>	<b>4</b>
<b>2</b>	<b>Responsibilities and action</b>	<b>4</b>
2.1	This procedure is to be	4
2.2	Organization Chart	4
2.3	Resources: plant (main equipment) and labor power	4
<b>3</b>	<b>References</b>	<b>4</b>
<b>4</b>	<b>Abbreviations</b>	<b>5</b>
<b>5</b>	<b>Method Statement</b>	<b>5</b>
5.1	Pre-stressing system	5
5.1.1	VSL post-tensioning system	5
5.1.2	Equipment	5
5.2	Calibration of hydraulic stressing jack	6
5.2.1	Equipment	6
5.2.2	General	6
5.2.3	Method	6
5.3	Installation of anchorage	7
5.3.1	Material	7
5.3.2	Method	7
5.4	Installation of HDPE pipe	7
5.4.1	Material	7
5.4.2	Method	7
5.5	Threading of tendons	8
5.5.1	Equipment	8
5.5.2	Material	8
5.5.3	Method	9
5.6	Installation of anchor head/wedges	9
5.6.1	Material	9
5.6.2	Method	9
5.7	Stressing of tendons	9
5.7.1	Equipment	9
5.7.2	General	10
5.7.3	Method	10
5.7.4	Stressing report	11
5.8	Sealing of anchor head	11
5.8.1	Material	11
5.8.2	General	11
5.8.3	Method	11
5.9	Water test	11
5.9.1	Equipment	11
5.9.2	General	12
5.9.3	Method	12
5.10	Grouting of tendons	14
5.10.1	Equipment	14
5.10.2	Materials	14
5.10.3	General	14
5.10.4	Method	14
<b>6</b>	<b>Quality</b>	<b>15</b>
6.1	Inspection Test Plan	15
6.2	Control Sheets	15



<b>7 Safety</b>	16
7.1 Lifting of Material and Equipment	16
7.2 Prestressing Tendon Installation	16
7.3 Tendon Prestressing	16
7.4 Grouting	16
<b>8 Environment</b>	17
<b>APPENDIX 1 - METHOD STATEMENT</b>	18
<b>APPENDIX 2 - INSPECTION &amp; TEST PLAN</b>	55
<b>APPENDIX 3 - SAFETY RISK ASSESSMENT</b>	58
<b>APPENDIX 4 - ASSOCIATED CONTROL SHEETS</b>	64

## 1 Scope of works and purpose

This Method Statement describes the external prestressing works for all the bridges type A, B, and C of the Hong Kong – Shenzhen Western Corridor, in terms of

- Methods of construction
- Quality Control
- Safety / Environmental precautions

## 2 Responsibilities and action

### 2.1 This procedure is to be

		At the moment
Written/updated	Engineer	Andy Kwok
Checked	Method Manager	Henry Chan
Approved	Technical Manager	P Burtet

It has to be used by all parties working on the external prestressing works, such as VSL and their sub-contractors.

### 2.2 Organization Chart

Descriptions of these responsibilities are provided in the VSL Quality Assurance Plan ref. GSL/SWC/VSL/5/00/001

Name of management staff are given through the organization chart ref GSL/SWC/VSL/5/00/031

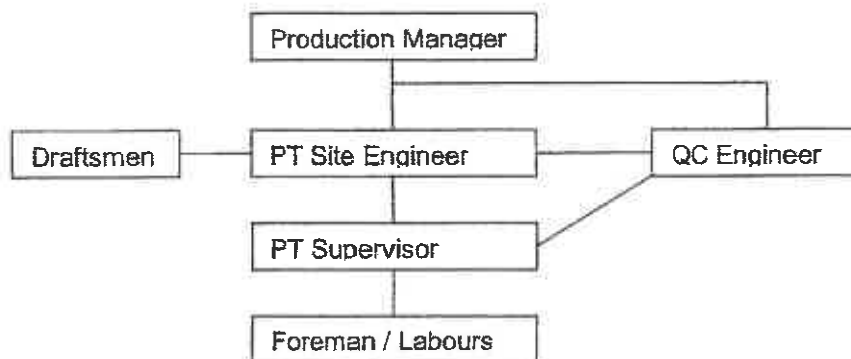

### 2.3 Resources: plant (main equipment) and labor power

For plant, refer to method statement in paragraph 5. Labour power is composed by one qualified foreman and 6 experimented workers.

## 3 References

Document	Reference
Volume 3 part 1 of contract HY/2002/21	
General Specification section 17 and Particular Specification section 17	
Quality Assurance Plan of VSL	GSL/SWC/VSL/5/00/001
Manual of Organization by Name	GSL/SWC/VSL/5/00/031
VSL Safety Manual	GSL/SWC/VSL/6/00/001
VSL Environment Manual	GSL/SWC/VSL/7/00/001

## 4 Abbreviations

MSI	Methods Statement
ITP	Inspection Test Plan

## 5 Method Statement

The method statement for external prestressing works is described as below.

### 5.1 Pre-stressing system

#### 5.1.1 VSL post-tensioning system

All external tendons shall be VSL Post-Tensioning System Type EC, which consists of:

External Tendon (including Spare Tendon)					
Tendon Type/Strand no.	VSL Wedge	Ø of Super Strand with BS5896*	HDPE (DIA./THK) mm	Casting Type	Anchorage Block (thk./OD/recess)
6-28	0.6" Super	15.7mm	160/9.1	EC 5-55sc	EC 6-37 (145/320/229) modified
6-31					
6-34					
6-37					

Note: \* ~ Strand to be 15.7mm dia. low relaxation 7-wire super strands (class 2) confirming to BS5896 :1980. Minimum breaking load 279kN

- HDPE trumpet
- Protection cap
- HDPE sleeve coupler

#### 5.1.2 Equipment

For stressing of Tendon:

- VSL stressing jack type ZPE-1000
- Pressure Gauge.
- Hydraulic Pump.

For strand installation:

- Bri-pack (strand dispenser).
- Strand Pushing Machine.

For grouting:

- Grout Mixer Pump.

## 5.2 Calibration of hydraulic stressing jack

### 5.2.1 Equipment

- VSL ZPE-1000 hydraulic prestressing jacks connecting with pressure gauges.
- Electrically driven hydraulic pump.
- Master pressure gauge.
- 4 pieces for ZPE-1000.
- Load cells with Serial No.720
- Steel ruler

(Schematic set-up for jack calibration is attached in appendix 1)

### 5.2.2 General

The purpose of this procedure is to ensure that each hydraulic jack to be used on project site is calibrated to ensure the accuracy of measurement.

### 5.2.3 Method

#### Pre-calibration Preparation

- i. The Store Supervisor (attached relevant CV in appendix 1) shall identify the jack to be calibrated and ensure the load cell to be used has the valid calibration certificate (within 2 years).
- ii. The Operator shall set up the equipment, jack, load cell, stressing chair, etc., for jack calibration.

#### Calibration Procedure

- i. Increase the pressure and record the reading of the jack gauge and the load cell's digital at every 10MPa increment of the reference gauge until the working capacity of the jack is reached.
- ii. Release the jack pressure and repeat step 1 for two more times.
- iii. The Operator shall record the calibration data on the Jack Calibration Certificate (Form No. CA-01, see appendix 4).

#### Calibration Certificate

- i. The Store Supervisor or the Operator shall complete the Jack Calibration Certificate (Form No. CA-01) by calculating the following:
  - a. Average measured load and jack gauge readings of the three runs
  - b. Linear equation between the measured load and jack gauge readings by linear regression method
- ii. The Jack Calibration Certificate (Form No. CA-01) shall be checked by the Quality Assurance Manager/Engineer and signed by the witness if any.

#### Calibration Report

The report shall include:

- i. Calibration report of the load cells.
- ii. Calibration report of the calibrated ZPE-1000 jacks

### 5.3 Installation of anchorage

(The following operation will be carried out at Precast yard)

#### 5.3.1 Material

- VSL HDPE trumpet
- Casting for EC5-55Sc

#### 5.3.2 Method

1. Fix the casting EC5-55Sc onto the formwork by using bolts and nuts. Ensure the grout inlet is oriented at the top of casting and properly sealed with mastic tape or similar to prevent ingress of grout during concreting.
2. The casting shall be fixed perpendicularly to the tendon axes either onto the end shutter or the recess formwork as detailed in the working drawings. The edge of the casting shall be sealed to prevent ingress of grout during concreting.
3. Fix the guide pipe between the casting and the stop end
4. Fix bursting reinforcement, as per the working drawings, behind the anchorage.
5. Strip the formwork after the concrete has been placed and achieved an appropriate strength.
6. Check and clean the casting surface of the anchorage by removing any cement slurry adhered to it during concreting.
7. Install the trumpet into the casting as per the working drawings.

### 5.4 Installation of HDPE pipe

#### 5.4.1 Material

1.  $\phi$  160mm O.D. HDPE pipe for tendon 6-28, 6-31, 6-34 & 6-37
2. 17/23mm grout hose.

#### 5.4.2 Method

1. Label tendon numbers on the anchorage faces and on the faces of intermediate deviator diaphragm for the corresponding tendon identification and duct installation.
2. Connect individual HDPE pipe together by minor weld method wherever practicable.
3. Insert the HDPE duct section into the intermediate deviator segments.
4. When necessary, temporary support shall be erected for supporting the tendon before threading of strand.
5. Grout vent is provided at the highest and lowest points of the tendon profiles. Additional vents will be provided at 15m spacing from this vent if the tendon is long enough. (see Appendix 1)
6. To install an intermediate vent, drill a hole through the HDPE duct at a desired position. To avoid damaging of the strand inside, a core bit for wood drilling should be used. 17/23 mm grout hose is welded to the hole previously drilled on the tendon duct as immediate vents.

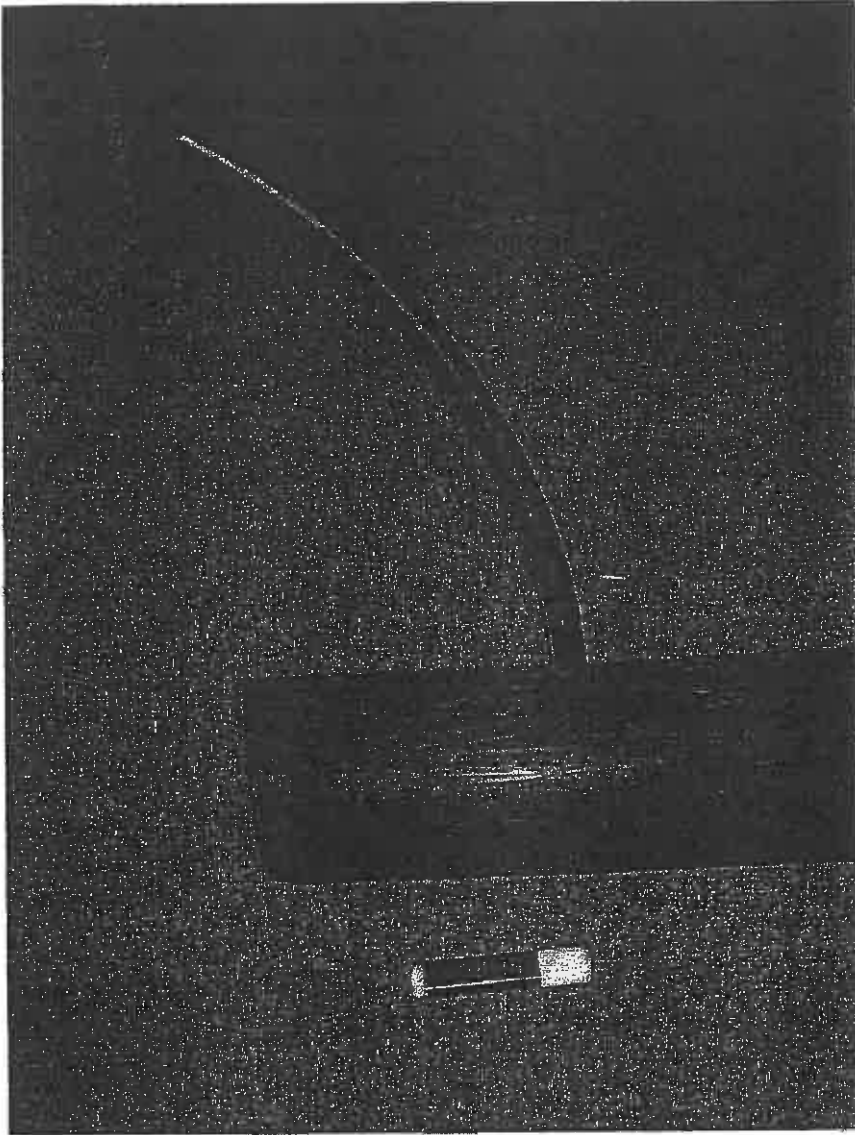

17/23 mm grout hose is welded to the hole previously drilled on the tendon duct as immediate vents

## 5.5 Threading of tendons

### 5.5.1 Equipment

- VSL push-through machine.
- Electric disc cutter.

### 5.5.2 Material

- 15.7mm diameter low relaxation 7-wire super strands conforming to BS5896-1980
- Pre-stressing tendons from each batch shall not be installed until testing of the batch has been completed
- Strands shall be coated with water-soluble oil before delivery to site.



### 5.5.3 Method

1. Prior segment erection, introduction of a "mouse" or dolly inside tendon sheath to check if it is free from obstacle.
2. Prior to installation of the strands, ER's staff should be invited to inspect whether testing of the batch has been completed and whether the strands and sheaths are free from loose mill scale, loose rust or grease.
3. Strands which will be tensioned in one operation shall be taken from the same batch.
4. Set up strand dispenser on the deck within an ease working distance and location.
5. Thread the strand into the push-through machine with a metal guide cap at the front end of the strand for ease of threading.
6. Start the machine and thread the strand through at constant speed. Check the unwinding of strand from the dispenser constantly until the strand emerges at the opposite end of the tendon.
7. Check the length of strand at the opposite end. The projection length shall be based on the length of jack to be used.
8. Remove the metal guide cap at the opposite end (outlet) and cut the strand with a disc cutter at the threading end (inlet).
9. Repeat the above steps until the required number of strand have been placed in the duct. Record the heat/coil nos. of the strand, which have been threaded in the tendon for future calculation of modified expected extension.
10. Wrap and protect the projecting strands with plastic foil if stressing will not be carried out within two weeks.

## 5.6 Installation of anchor head/wedges

### 5.6.1 Material

- Anchor Block EC6-37
- 15.7mm wedges for 15.7mm diameter strands

### 5.6.2 Method

- Before stressing, install the anchor block through the strands right against the casting.
- Place wedges to hold the anchor block in position

## 5.7 Stressing of tendons

### 5.7.1 Equipment

- VSL hydraulic prestressing jack type ZPE-1000
- Electric operated hydraulic pump.
- Pressure gauge.

### 5.7.2 General

1. Check the validity of the jack calibration certificate, if it is over six months, the jacks shall be re-calibrated before use.
2. A tensioning schedule will be submitted to the Engineer for approval at least 48 hours before each post-tensioning operation starts. The schedule will include the proposed sequence of tensioning the prestressing tendons, the required prestressing loads and the calculated extensions of the prestressing tendons as specified in the working drawings.
3. Stressing will be carried out under the instruction of the Main Contractor.
4. At the anchor block, strands are painted along a reference line prior to stressing, for checking of any possible wedge slippage during stressing and after the wedges are draw-in.
5. Stressing jacks will be handled by chain blocks and slings through the reserved holes within the deck and through the lifting devices at stressing platform outside the deck.
6. Warning sign boards or protection barrier shall be located behind stressing anchorage to keep other personnel out of the stressing zone.
7. Stressing shall be carried out by experienced personnel.
8. Stressing can be commenced after the concrete has attained a transfer strength as specified on the drawing. The maximum allowable tendon force at the stressing end shall be as per the working drawings.
9. Stressing end stressing sequence shall be in accordance with the latest version of working drawing or instruction given by the Engineer.

### 5.7.3 Method

1. The jack and the recess plate for draw-in are threaded and positioned against the anchor blocks. Generally the jack is fixed with chain blocks to chain or sling through holes in the top slab for the stressing operation.
2. The strands are painted along a reference line to indicate if any slippage occurs after the wedges draw-in and set.
3. A reference point for extension measurement is made on one or two strands. This can be done by using an aluminum bar fixed to one of the strand with a bolt.
4. Connect the hydraulic pump and the pressure gauge to the jack.
5. Apply an initial load, usually 5Mpa or 50 Bar, to take up slack of the strands and the measurement of the strand is recorded.
6. Inspect all the sleeve joint connection to see if a reasonable gap (20mm-50mm) is still maintained. Cut off a short piece of HDPE duct to maintain this kind of gap at sleeve joints. Cutting shall be done carefully with handsaw in order not to damage any strand inside.
7. Inspect all the temporary supports to see if the tendon is free standing by itself without touching those supports. If not, release the temporary support before continue stressing.
8. Increase the jacking pressure, record the strand extension measurement and the corresponding pressure at suitable intervals. Usually, an increment of 5MPa or 50 Bar is preferred. Reset is need whenever the jack comes near to its end of stroke travel.
9. When the pressure equivalent to the required jacking load is attained, the tendon is locked off by releasing the pump pressure so that to allow the wedges to draw-in and to lock of individual strand. The draw-in measurement is taken when the pressure is release back to the initial reading, i.e. 5Mpa or 50Bar.
10. The jack is then retracted and removed.

11. One set of stressing report comprised of 3 copies will be prepared during stressing of each tendon. The original white copy will be submitted to the Engineer by the Main Contractor, the blue copy will be kept by the Main Contractor and the yellow copy will be kept by VSL.
12. The complete set of stressing report will be submitted to the Engineer by the Main Contractor.
13. If the percentage of extension variation complies with the specification, strand cropping could be commenced.

#### 5.7.4 Stressing report

1. The stressing report will record the details of the stressed tendon and the extension measurement.
2. The report will also show the measured extension of the tendon and the variance from the theoretical extension.
3. Stressing report is to be recorded by VSL's foreman and checked by the Project Engineer. If the measured extension for the whole structure is within  $\pm 5\%$  (within  $\pm 10\%$  for individual tendons) of the adjusted theoretical extension, cropping of strands shall be commenced and the anchor heads are rendered with cement mortar to seal wedge cavities.
4. If the measured extension is less than 95% of the adjusted theoretical extension. The prestressing force shall be increased until 95% of the adjusted theoretical extension is achieved except that the prestressing force shall not exceed 80% UTS of the tendon.
5. The Engineer shall be informed immediately for solution, if the above procedures item 3 and item 4 fail to produce an average extension variation of  $\pm 5\%$ .

### 5.8 Sealing of anchor head

#### 5.8.1 Material

- Protection Cap for tendon 6-28, 6-31, 6-34 & 6-37
- M12 bolt and nut

#### 5.8.2 General

Upon receipt approval of the stressing result, protruding strands outside the anchor block are cut at a distance of 13mm approximately measured from the surface of the anchor block.

#### 5.8.3 Method

1. A reusable protection cap is used at the casting surface for sealing of the anchor lead.
2. Apply silicate sealant onto the surface of the casting before installing the protection cap.

### 5.9 Water test

#### 5.9.1 Equipment

- Air compressor

### 5.9.2 General

Tendons are filled up with water and pressurized to 0.5MPa or above for testing of the mirror welded and sleeve joints.

### 5.9.3 Method

1. Drill a 20 mm diameter hole through the HDPE duct along the tendon for all intermediate vents.
2. Install metal grout vents to all positions beyond the trumpet. A ball valve with a coupling device is attached to the end of this metal vent as grout inlet. 17/23 mm grout hose is welded to the hole previously drilled on the tendon duct as immediate vents.
3. Attach a rubber delivery grout hose to the metal vent on step 2 above with a closing valve at its end.
4. Grease part of the duct to be coupled. Slide the sleeve couplers over an O-ring on the duct provided at each side of the joints. Tighten the couplers on the ducts with two number of omega clamps, one at each end of the sleeve couplers to tightened the joints to an air and watertight condition.
5. Open all the valves of the tendon and fill the tendon up with water through the grout inlet. Install a pressure gauge and a T-valve in front of the grout inlet for pressure monitoring.
6. When water is coming out from it without any trapping air, close up the valves/vents one by one, except the inlet valve.
7. The tendon is then pressurized to a pressure of 0.5MPa or above. The pressure can be maintained to 0.5MPa or above by continuous pumping prior the pressure dropped below 0.5MPa.
8. If there is leakage of water, apply a temporary water-plug product and repeat the water test, if no more leakage, remove the water-plug for repairing of the concrete.
9. After the tendon is tested to be able to sustain a pressure of 0.5MPa or above, blow out the water from the tendon and discharge it to the drains provided by Main Contractor.

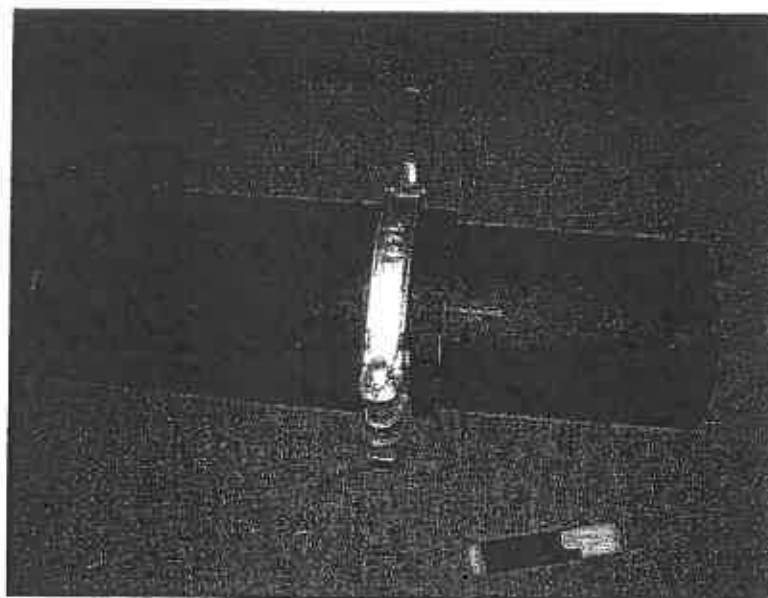

Tighten the couplers on the ducts with omega clamp

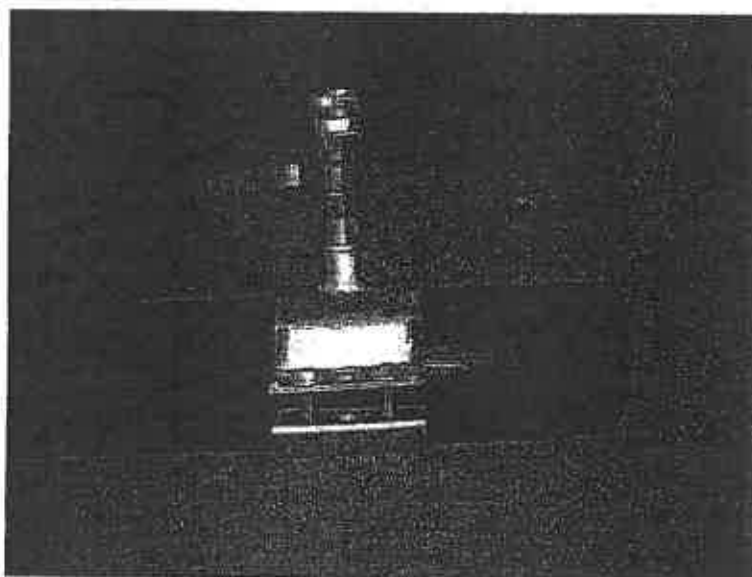

Install metal grout vents

## 5.10 Grouting of tendons

### 5.10.1 Equipment

- Grout Plant (COLOMONO 10 Grout Pump).

### 5.10.2 Materials

Grout mix shall be as follow:

<u>Material</u>	<u>Proportion</u>
a) Ordinary Portland cement (Champion Brand)	
b) W/C ratio	0.33
c) Flowcable/RHEOMAC GF320	3% by weight of cement
d) Pozzolith 300-R	4 ml/kg of cement

### 5.10.3 General

1. Grouting of ducts shall be carried out within 28 days of installation of the tendon or as soon as is practicable thereafter.
2. Unless otherwise permitted by the Engineer the tendons shall not be cut until at least 1 day after stressing.
3. Mixing procedure shall be as follow:
  - i. Grout is to be mixed with VSL grout mixer / pump which is a blade type centre agitated machine.
  - ii. Discharge the required volume of water into the grout mixer.
  - iii. Turn on the grout pump and add in the pre-determined amount of Pozzolith 300 R and then Rheomac GF320 into the mixing tank. Continue mixing for 1½ to 2 minutes.
  - iv. Add in cement, bag by bag, to the mixing tank. Continue mixing until the grout mix is consistent.
  - v. A strainer shall be provided in the path of the grout circulation in order to catch cement lump, if any.

### 5.10.4 Method

1. All ducts shall be kept free from standing water and shall be thoroughly clean before grouting.
2. Sealing at the end of the anchor head.
3. Equip grout inlet and outlet with ball valves and extension pieces of G.I. short pipe.
4. Grout is then pumped through the Grout inlet from the lower end of the tendon until it expels out the grout vents. Inspect the expelled grout to see if it is free from air bubble and in consistent with the grout as in the mixer. The grout vent can then be closed. Waste grout shall be collected in buckets and discarded to the public bin provided by the Main Contractor.
5. Grouting of each tendon should be carried out in one continuous operation. If grouting is interrupted for more than 1 1/2 hours, the tendon shall be flushed with water and the tendon shall be blown clean with compressed air.
6. When the last grout vent is closed off and the inlet value still being opened, maintain the grout pressure to 0.5MPa or above for 5 minutes to check if there is any pressure drop.
7. Sample of grout will be taken from every 25 batches of grout, or from the amount of grout produced in a day, whichever is the lesser, to determine the crushing strength and bleeding of the grout. Grout cubes will be submitted to Engineer for delivery to government laboratory for testing.
8. The filled ducts shall not be subject to shock or vibration within 24 hours of grouting.
9. All grout hoses and pipes can be cut and removed 24 hours after grouting. In case of the grout vent duct is not fully filled, inform the Engineer before any topping up will take place.
10. Testing of grout crushing strength shall be in accordance with PS17.62S & 17.63.

11. Fluidity testing for grout shall be carried out in accordance with PS 17.65 to 17.77.
12. Sedimentation testing for grout shall be carried out in accordance with PS 17.78 & 17.79.
13. Testing of bleeding and volume change shall be in accordance with PS 17.59S & 17.60S.

## 6 Quality

### 6.1 Inspection Test Plan

The Inspection Test Plan is a chronological list of all the controls that have to be carried out during the works. For each control, it lists:

- The task being in progress
- The control and/or test to be done and the required equipment if necessary
- The criteria of acceptance
- The person in charge to carry out the control and/or test
- The reference of the Control Sheet where the control is to be recorded
- Action to be done if non-conformance

It also says if the control / test is a Hold Point

The intervention level during such inspection or test is given for each people involved.

The Inspection Test Plan for the works is attached to this document, Appendix 2.

### 6.2 Control Sheets

The Control Sheets are used on site to record the controls/tests that are carried out according to the Inspection Test Plan.

They are all grouped in Appendix 4.



## 7 Safety

The Project Engineer shall act as a safety coordinator on site for stressing operation.

Appropriate personal protective equipment (such as safety helmet, safety boots, etc.) shall be issued to all site workers and properly recorded.

Any safety hazard and accident shall be reported to the Safety Officer of the Main Contractor as soon as possible.

### 7.1 Lifting of Material and Equipment

Each item of lifting equipment shall have a valid test certificate.

Items to be lifted shall be suspended from designated lifting points or at points such that the item being lifted hangs in a balanced condition.

No person shall stand or work under the load being lifted.

Care should be taken when stacking items in more than one layer to ensure the pile is stable.

### 7.2 Prestressing Tendon Installation

The working area for strand threading shall be identified as an exclusion zone where only VSL's personnel and the representatives of the Engineer and Contractor are allowed to enter.

The strand pusher and dispensing coil shall be positioned in line with the tendon. When this is not possible, a guide pipe (corrugated steel or PE) may be used as necessary to guide the strand between the strand dispenser and pushing machine.

Protective eye goggles should be worn when cutting the strand with a disc cutter.

### 7.3 Tendon Prestressing

The working area for stressing shall be identified as exclusion zone where only VSL's personnel and the representatives of the Engineer and Contractor are allowed to enter.

A warning sign shall be erected at the stressing and non-stressing ends whenever stressing is in progress.

When site personnel are working beyond an exclusion zone, a plywood board shall be provided in front of the tendon at both the stressing and non-stressing ends to stop the strand in case of strand breakage.

### 7.4 Grouting

Plastic gloves and dust mask should be worn when handling cement and grout.

Protective eye goggles should be worn when inspecting grout outlet pipe under pressure.



## 8 Environment

Generally, operations of pre-stressing and grouting do not disturb the environment of the neighborhood.

- 1) Pre-stressing and grouting do not give out any toxic gases and do not disturb the air quality.
- 2) Noises emitted during operations do not exceed 75db.
- 3) The waste grout will be collected in buckets.

**APPENDIX 1****(31 PAGE)****METHOD STATEMENT  
ANNEX DOCUMENT****Calibration of Stressing Jack**

Schematic Set-up for Jack Calibration

CV of Calibration Supervisor

**Position of Grout Vent****Particular of grout mix**

Technical Information of RHEOMAC GF320

Technical Information of POZZOLITH 300R

**Brochure and sketches**

VSL Type EC Anchorage

VSL Jacks for type EC Anchorage

Typical VSL Stressing Jack Installation

Sketch : Anchorage details for external PT

Typical external pre-stressed tendon layout for:

- Bridge type A: 23511/06/621

- Bridge type B: 23511/06/622

- Bridge type C: 23511/06/623

**Calibration load cell report**

Test certificate of "Champion" cement

Grout strength report (sample)

Calculations of stressing report (formulae)

SKETCH 1

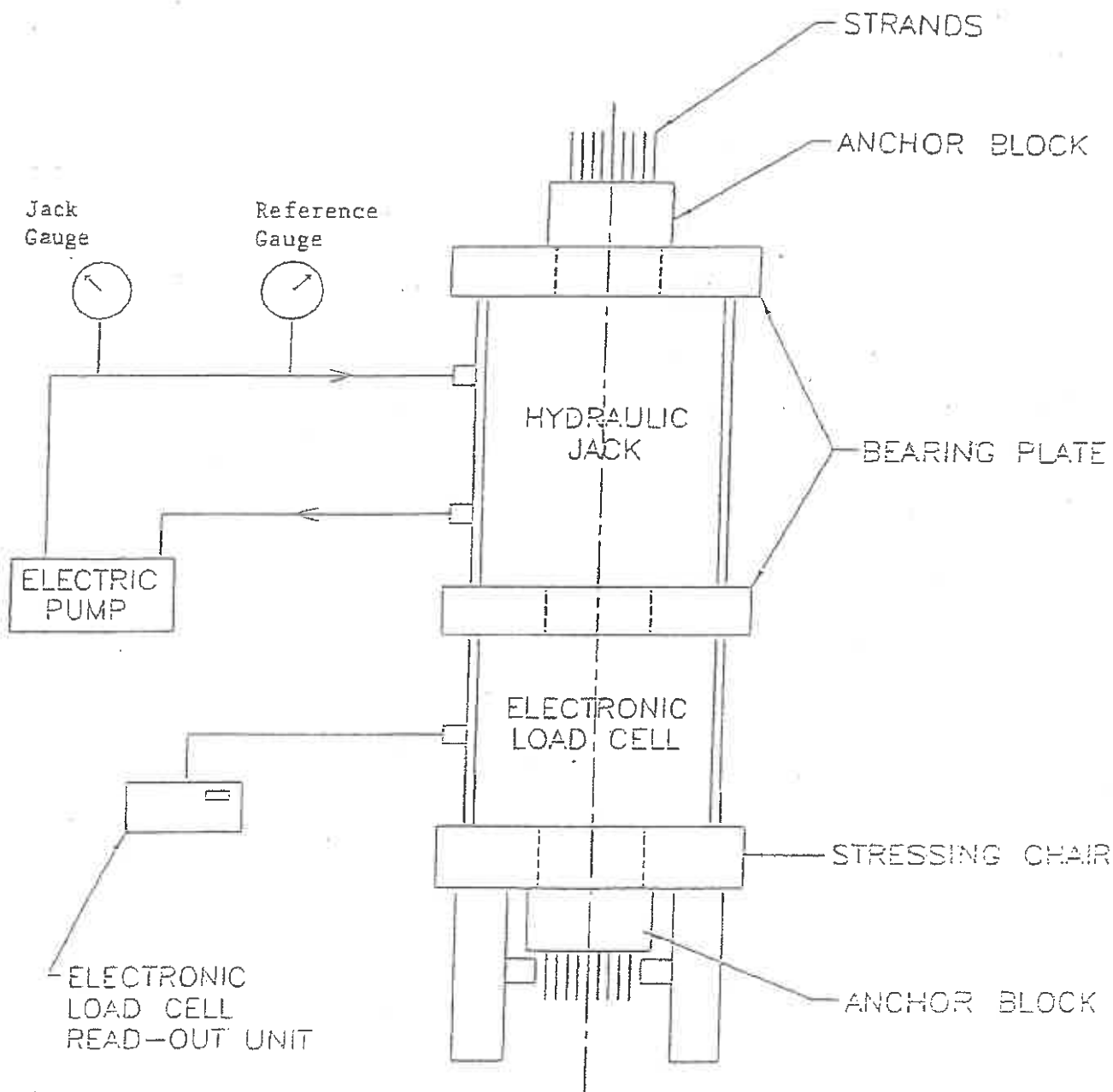

SCHEMATIC SET-UP FOR JACK CALIBRATION

Sketch No. D19-SK01-A

19/73

Personal Details

Language : Chinese, English  
 Company Name : VSL Hong Kong Ltd.  
 Company Address : 51/F Hopewell Centre  
 183 Queen's Road East  
 Wanchai  
 Hong Kong  
 Service with VSL : 20 years  
 Position : Store Supervisor

Major VSL Jack Calibration Experiences

1983 – Present	Project Name	Date
	Contract CV2001/10 Penny's Bay Dev't Contract 2	2002 – 2003
	Contract CV2000/09 Pennys' Bay Dev't Contract	2002 – 2004
	Contract No. 10/2000 Northern Access Road for Cyberport Dev't	2002 – 2003
	KCRC East Rail Contract TCC200 & TCC300 Tai Wai to Shek Mun to Lee On	2001 – 2002
	Contract YL49/2000 Hung Shui Kiu North Phase 1	2001 – 2002
	Contract CC203 Tin Shui Wai Station	2001 – 2001
	KCRC West Rail Contract CC212 & CC213 Tuen Mun Centre Station	1999 – 2001
	KCRC West Rail Contract CC201 & CC211 Kam Tin to Tin Shui Wai	1999 – 2001
	Contract YL39/98 Tin Shui Wai Further Dev't	1999 – 2000
	Hung Hom Bypass Contract HY/94/13	1997 – 1999
	Ma Wan Viaduct	1998 – 1999
	Duplicate Tsing Yi South Bridge Contract TW/90/95	1996 – 1998
	MTRC Contract 509 Kwai Chung Park Viaduct	1996 – 1997
	MTR 510 Rambler Channel Bridge	1995 – 1997
	Cheung Ching Viaduct	1995 – 1996
	Rambler Channel Bridge & Associated Roadworks Contract HY/92/03	1994 – 1996
	MTRC 502 Immersed Tube Tunnel	1994 – 1995
	Cont HY92/18 Lantau Fixed Crossing Tsing Ma Bridge	1993 – 1995
	Lantau Fixed Crossing Kap Shui Mun & Ma Wan Viaduct	1993 – 1996
	West Kowloon Corridor – Yaumatei Section, Phase II	1993 – 1995
	Western Harbour Crossing Sai Ying Pun Interchange & Route 7 works	1994 – 1997
	West Kowloon Expressway South Section (HY/92/18)	1993 – 1996
	Second Ap Lei Chau Balanced Cantilever Bridge	1993 – 1994
	TW74 Texaco Road	1993 – 1994
	Shatin New Town – T6 Contract TDD ST45/87	1989 – 1990
	Tate's Cairn Tunnel – Shatin Approaches	1988 – 1989
	Kwun Tong Bypass Phase II & III	1989 – 1991
	Kwun Tong Bypass Phase I	1988 – 1989
	Kwun Tong Bypass – Lei Yue Mun	1988 – 1989
	Rumsey Street Flyover Contract HY/85/45	1988 – 1989
	Route 5 Shatin To Tsuen Wan Contract HY/85/06	1987 – 1988

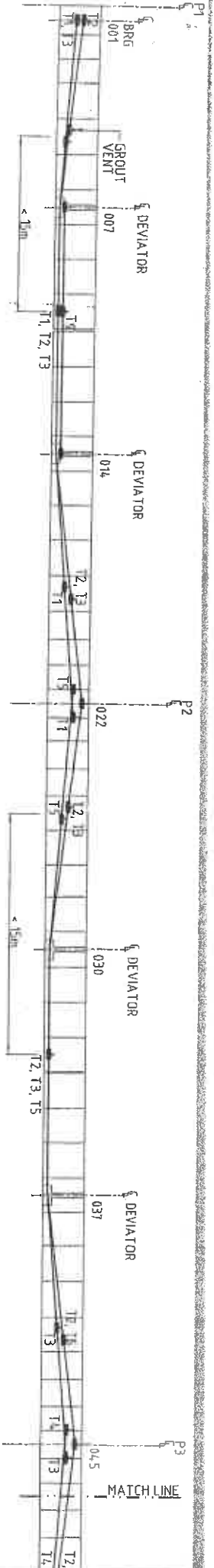

ELEVATION (BRIDGE TYPE A)

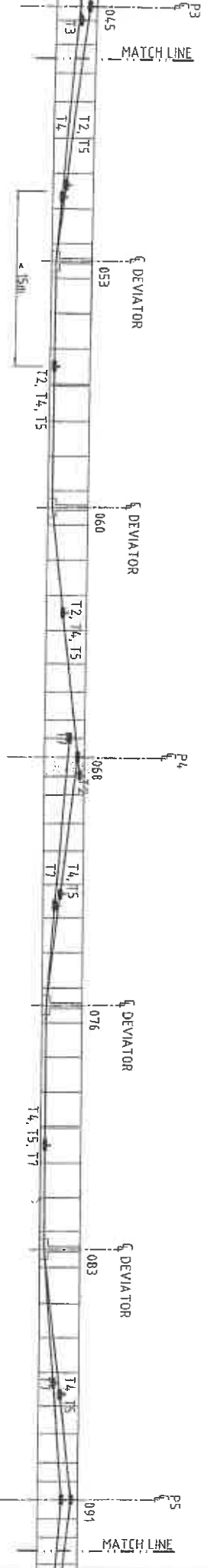

ELEVATION (BRIDGE TYPE A)

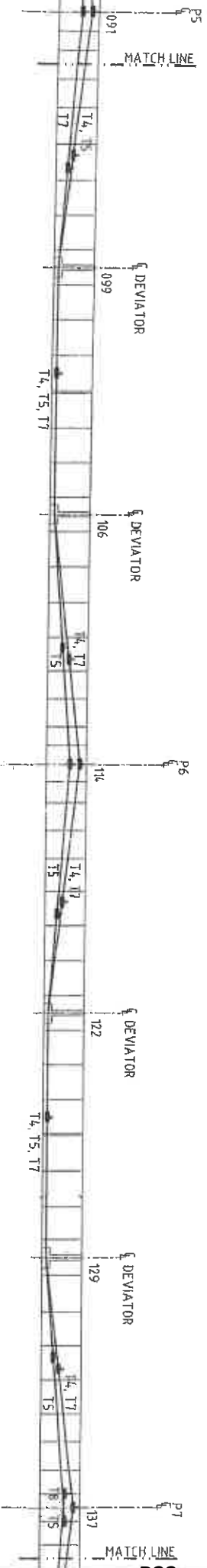

ELEVATION (BRIDGE TYPE A)

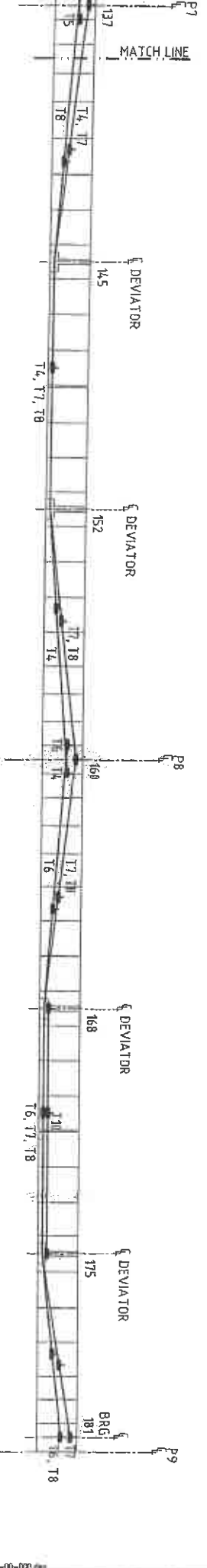

ELEVATION (BRIDGE TYPE A)

\* THE LOCATION OF GROUT VENT TO BE DETERMINED ON SITE.

SKETCH

**G**  
**ARUP**  
 PROJECT  
 Contract No. HY/2002/21  
 Hong Kong - Shenzhen  
 Western Corridor

**VSL**  
 51st, Robinson Centre  
 110, Queen's Road East, Victoria, Hong Kong  
 Tel: (852) 2500 2288 Fax: (852) 2500 2289

REV	DATE	DESCRIPTION	BY	CHECK
0	11/1/06	SPU - PREP		
		PREP ISSUE		

DRAWING TITLE  
**GROUT & DRAIN VENT DETAILS (LD7)  
 FOR EXTERNAL TENDON  
 IN BRIDGE TYPE A**

SCALE: 1:400(A3)  
 DRAWING NUMBER: GS/SW/CV/SLDB/ /-/-  
 REVISION: 0  
 PAGE: 1/1

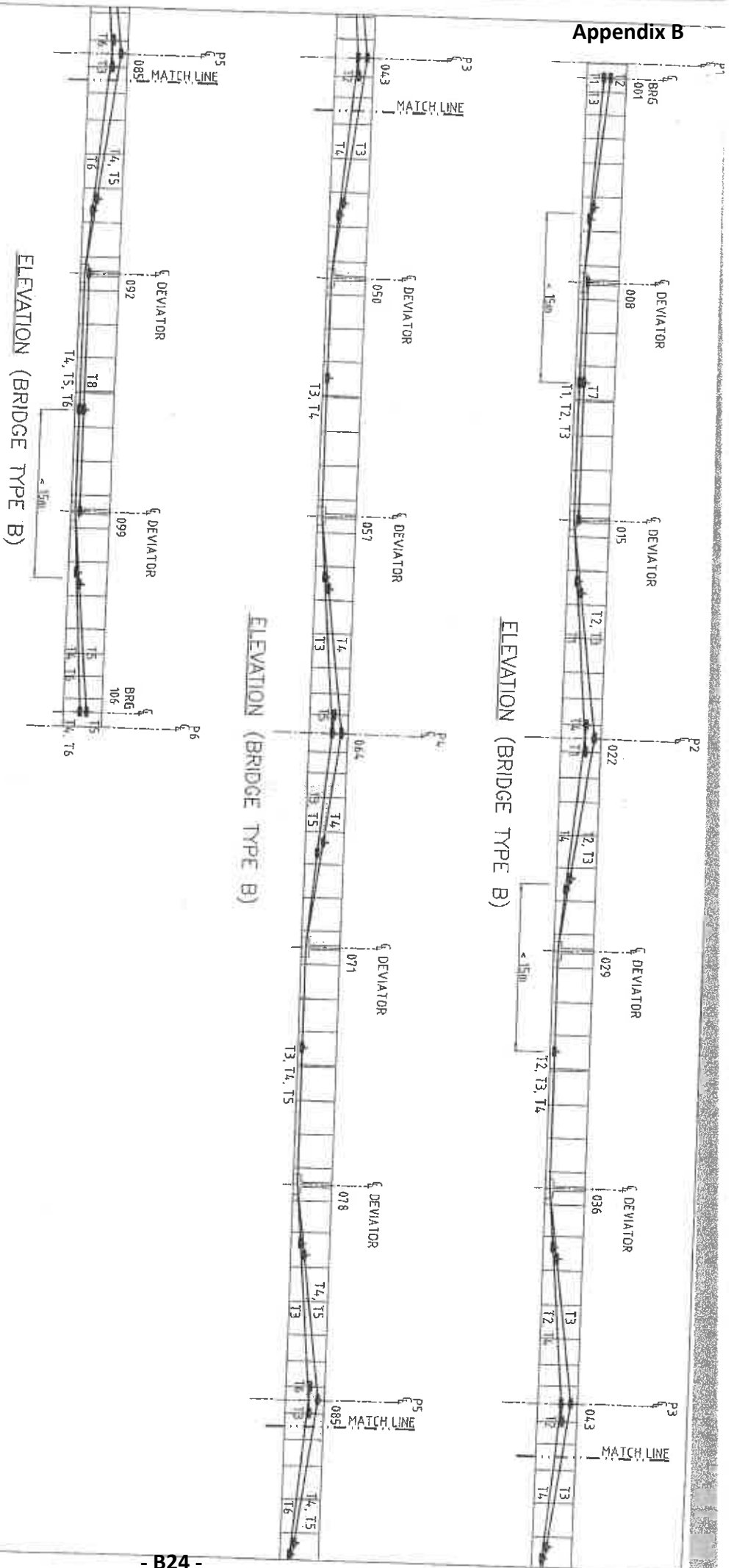

\* THE LOCATION OF GROUT VENT TO BE DETERMINED ON SITE.



ARUP

PROJECT  
 Contract No. HY/2002/21  
 Hong Kong - Shenzhen  
 Western Corridor



VSL  
 140, Queen's Road East, Hong Kong  
 Tel: (852) 2500 2200 Fax: (852) 2500 0200

REV	DATE	DESCRIPTION	PREP	CHECK	APPROVE
0	11/17/04				

DRAWING TITLE  
 GROUT & DRAIN VENT DETAILS (LD7)  
 FOR EXTERNAL TENDON  
 IN BRIDGE TYPE B

SCALE	1:400(A3)	REVISION	0	PAGE	1/1
DRAWING NUMBER	GSL/SWCV/SLDB/ 1-1				

SKETCH

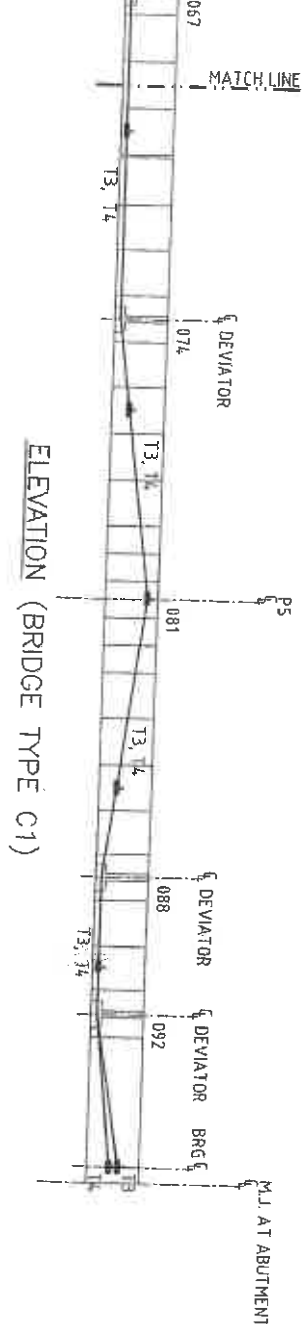
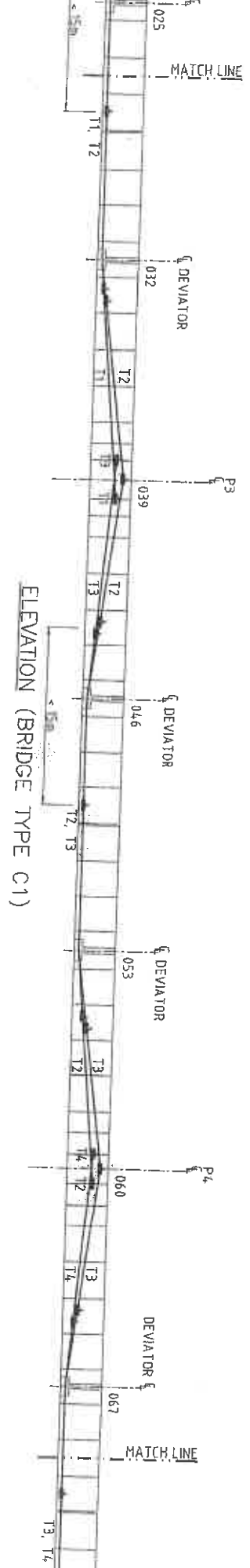
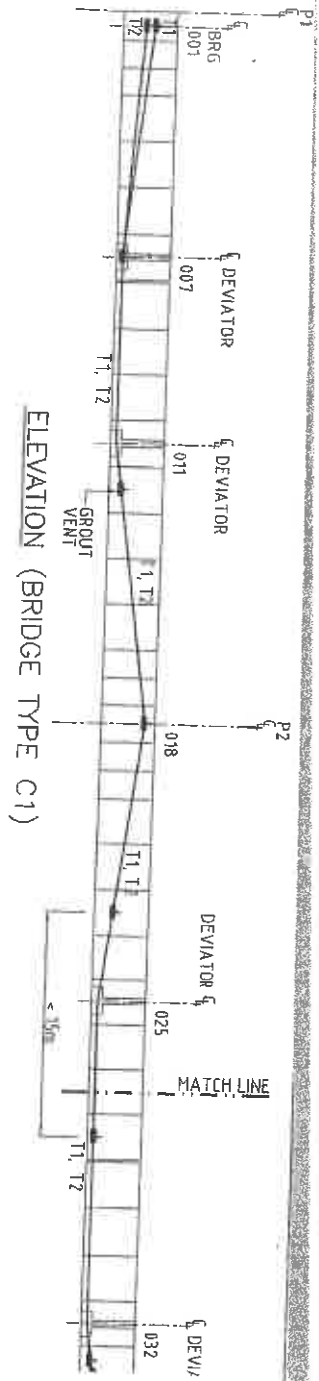

\* THE LOCATION OF GROUT VENT TO BE DETERMINED ON SITE.



ARUP

PROJECT  
 Contract No. HY/2002/21  
 Hong Kong - Shenzhen  
 Western Corridor



VSL  
 151, Queen's Road, Hong Kong  
 Tel: (852) 2000 2200 Fax: (852) 2000 1000

REV	DATE	BY	CHKD	DESCRIPTION
0	10.1.14	PBL	PBL	FIRST ISSUE

DRAWING TITLE  
 GROUT & DRAIN VENT DETAILS (LD7)  
 FOR EXTERNAL TENDON  
 IN BRIDGE TYPE C1

SKETCH

SCALE	1:400(A3)
DRAWING NUMBER	GSLUBA/VSLDB/1/1
REVISION	0
PAGE	1/1

Appendix B

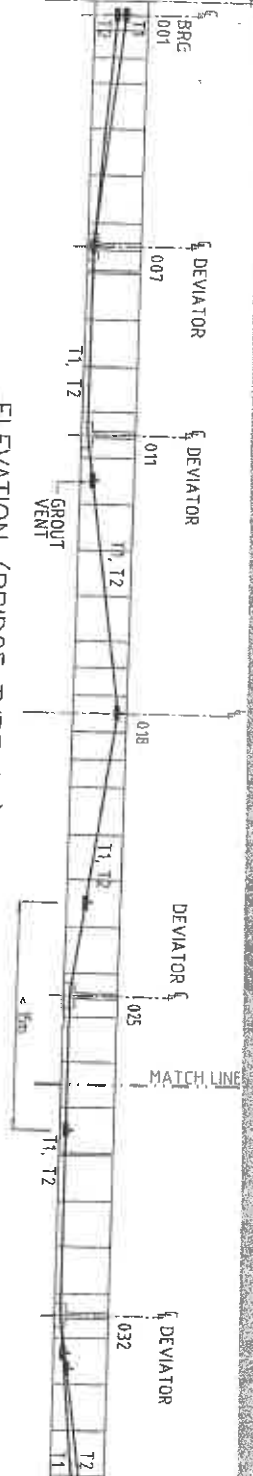

ELEVATION (BRIDGE TYPE C2)

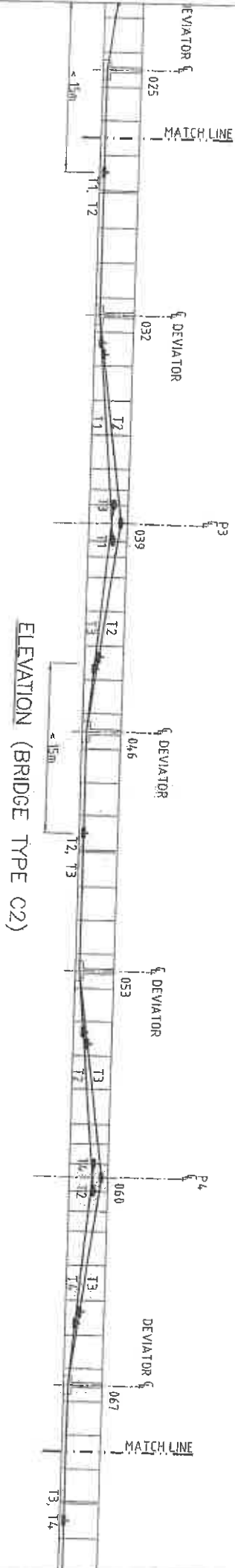

ELEVATION (BRIDGE TYPE C2)

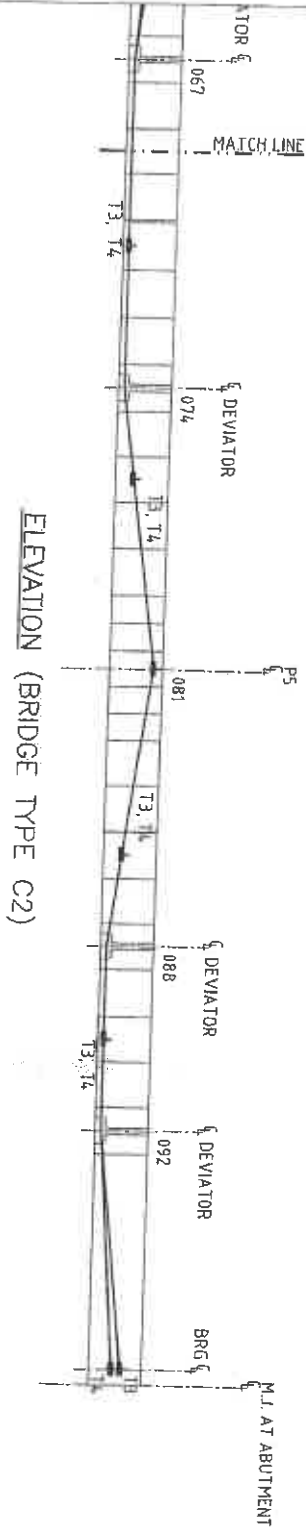

ELEVATION (BRIDGE TYPE C2)

\* THE LOCATION OF GROUT VENT TO BE DETERMINED ON SITE.



PROJECT

ARUP

Contract No. HY/2002/21  
Hong Kong - Shenzhen  
Western Corridor



VSL China  
153, Chongqing Road, Shanghai  
Tel: (8621) 2206 2208 Fax: (8621) 2206 2209

REV	DATE	REASON	DESIGNER	CHECKER
0	T01	ISSUE	PHU	PHU

DRAWING TITLE

GROUT & DRAIN VENT DETAILS (LD7)  
FOR EXTERNAL TENDON  
IN BRIDGE TYPE C2

SKETCH

SCALE	REVISION	PAGE
1:400(A3)	0	1/1

DRAWING NUMBER  
GSL/SWCVSLDB/J-/



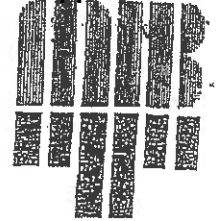

Master Builders  
Technologies

# RHEOMAC GF320

Formerly Flowcable  
Admixture for anchor grouting

## DESCRIPTION

Rheomac GF320 is a powder admixture, which when mixed in specified quantities with cement and water yields a shrinkage compensated, thixotropic, pumpable grout. The admixture also has efficient water reducing properties that help to maintain a low water cement ratio of approximately 0.25 and hence imparts high strength to the grout.

## RECOMENDED FOR

Rheomac GF320 is recommended in situations where steel anchors (e.g. rock anchors) and cables (e.g. prestressed cables) are required to be firmly anchored or grouted, and protected from corrosive attack of subsoil water. It is ideal for overhead anchoring due to its thixotropic properties. Applications include both pre-grouted and post-grouted anchors and cables such as:

- tube bolt anchoring.
- roof stitching in mines and tunnels using wire ropes.
- grouting of pre-stressed anchors in rock and soil.
- contact grouting.
- grouting of cable ducts.

## FEATURES AND BENEFITS

<i>Shrinkage compensated</i>	Continues to retain filled volume. Efficient anchoring.
<i>Thixotropic</i>	Grout does not flow out of overhead holes.
<i>Pumpable</i>	Advantage in deep hole or cable duct grouting.
<i>Dense micro structure</i>	Resists water ingress. Protects steel.
<i>High early and final strengths</i>	Early load transfer.
<i>Long open time</i>	Sufficient time to allow grout penetration even in difficult circumstances.

## PERFORMANCE DATA

Compressive strength (Typical with w/c : 0.25 @ 20°C)	
6 hours	: > 3 N/mm <sup>2</sup>
1 day	: > 30 N/mm <sup>2</sup>
28 days	: > 70 N/mm <sup>2</sup>

## PROPERTIES

Supply form	: powder
Colour	: pale grey
Storage	: 10-50°C
Solubility in water	: low
Chloride content	: < 0.1%

## APPLICATION

### Material Condition

Cement : For optimum performance, always use fine Portland cement, since the reactivity of cement is reduced with ageing.

### Mixing

Mechanical mixing is necessary. A high speed (approx. 1500 rpm) mixer is recommended.

Use Rheomac GF320 at a dose of 3-6% by weight of cement and mix water at approximately 25 L per 100 kg cement (i.e. w/c of 0.25).

*Note : finely ground cement normally requires a higher quantity of water.*

Place approximately 23 L of water in the mixer and add 5 kg of Rheomac GF320. Keeping the mixer running add 100 kg of cement slowly and mix for 3 minutes (5 minutes if a slow speed mixer is employed), until a lumpfree homogenous mix is obtained. If required add more water (from the remaining 2 L) until the required consistency is reached.

### Placing

Place the mixed grout using a normal grouting pump (small, worm or piston pump). Always use a stiff PVC hose to place the grout.

### Pre-grouted anchors

Introduce the PVC hose to the end of the hole and start pumping. While pumping, pull the hose back gradually, allowing the grout to completely fill the volume of the hole. Place the grout slowly and continuously.

Install the anchor carefully into the grouted hole so as to displace the grout to fill the annulus around the anchor completely. Mildly agitate the anchor to release any entrapped air around the anchor. Hold the anchor in position using a suitable device, until the grout attains initial set.

### Post grouted anchors, tube anchors

Connect the PVC hose to the anchor and install the anchor in the hole. Start pumping and continue until the grout starts issuing out between the rock and the bearing plate.

### Curing

Curing will not be required as the grout normally is completely enclosed.

**EQUIPMENT**

Mixing : High speed grout mixer or heavy duty slow speed drill fitted with a grout stirrer.

Placing : Worm or Piston type pump.

**CLEANING**

Use water to clean tools and equipment before the grout hardens.

**ESTIMATING DATA**

100 kg of cement mixed with 25 L of water and 5 kg of Rheomac GF320 yields approximately 60 L. Therefore material requirement will be 0.083 kg per litre of grout needed.

**PACKAGING**

Rheomac GF320 is supplied in 15 kg bags.

**SHELF LIFE**

Rheomac GF320 can be stored in unopened original bags for 12 months, if kept dry and at even temperature. Do not use the product if the bag is damaged, or has been open for over a month.

**PRECAUTION**

Health : Rheomac GF320 is alkaline like normal cement and can cause skin irritations to persons with sensitive skin.

Wear gloves and masks while handling the product. Take all precautions normally taken while handling cement.

Fire : Rheomac GF320 is not flammable.

**OTHER USEFUL PRODUCTS**

Meyco SA series : A range of high performance accelerating admixtures for sprayed concrete applications.

Meyco TCC activators : A range of speciality admixtures to be used in combination with certain selected MBT superplasticisers in shotcreting, for imparting such properties as instant slump loss, pumpability and total hydration.

Rheobuild : A range of high performance superplasticisers to produce Rheoplastic concrete.

Rheocem : A range of superfine cements for pressure grouting of micro cracks in concrete, rocks and soil.

Masterflow : A range of shrinkage compensated, free flowing grouts - cementitious and resin based - with exceptional strengths, for precision grouting of both dynamically loaded and static machinery and equipment.

**STATEMENT OF RESPONSIBILITY**

The technical information and application advice given in this MBT publication are based on the present state of our best scientific and practical knowledge. As the information herein is of a general nature no assumption can be made as to a product's suitability for a particular use or application and no warranty as to its accuracy, reliability or completeness either expressed or implied is given other than those required by law. The user, is responsible for checking the suitability of products for their intended use.

**NOTE**

Field service where provided, does not constitute supervisory responsibility. Suggestions made by MBT either orally or in writing may be followed, modified or rejected by the owner, engineer or contractor since they, and not MBT are responsible for carrying out procedures appropriate to a specific application.

Master Builders Technologies (HK) Ltd.  
20/F EW International Tower  
122-124 Texaco Road  
Tsuen Wan, N. T.  
Hong Kong  
Tel : (852) 2407 4291  
Fax : (852) 2406 7391



Certificate No: 83/2666  
(Singapore)

26/73

# POZZOLITH 300-R

Polymer admixture for improving concrete, meets and exceeds AS 1478, ASTM C 494 and BS 5075 requirements

## DESCRIPTION

POZZOLITH 300-R is a ready-to-use liquid admixture for making better, more uniform and more predictable high quality concrete. It retards the setting time to facilitate placing and finishing. It meets and exceeds AS 1478, ASTM C 494 Type B and D admixtures and BS 5075 Part 1 requirement.

## RECOMMENDED FOR

- all types of concrete where retardation of set and improved performance (particularly improved pumpability) are required
- improving pumped concrete, shotcrete (wet mix) and conventionally placed concrete
- improving plain, reinforced, precast, prestressed, light weight or standard weight concrete
- use with air-entraining agents approved under SAA, ASTM, AASHTO and BS 5075 specifications when air-entrained concrete is specified. (MBT approved air-entraining admixture MBVR is recommended for use with POZZOLITH 300-R admixture)

## FEATURES/BENEFITS

- mild to extended retardation
- reduce permeability
- improve waterlighthness
- superior finishing characteristics for slabwork and off-form surfaces
- reduce water content for a given workability
- increase compressive, flexural and bond strengths
- easier placement
- improve workability
- reduce segregation
- greater durability
- greater pumpability
- increase resistance of air entrained concrete to damage due to freezing, thawing and scaling from de-icing salts.

## PERFORMANCE

In comparison to plain concrete, a mix containing POZZOLITH 300-R develops higher early and ultimate strengths.

POZZOLITH 300-R exceeds the strength requirements of AS 1478, ASTM C 494, AASHTO M 194, CRD C87 and BS 5075 specifications.

## DOSAGE

POZZOLITH 300-R is recommended for use at a dosage rate of 300 +/- 50 ml per 100 kg of cement for most concrete mixes using average concrete ingredients, but it is appreciated that variations in the job conditions and concrete materials employed may make usage rates outside the recommended range desired.

Consult your local MBT field representative who is available to assist you in determining the dosage rate for best performance in your work.

## PACKAGING

205 litre drums or bulk delivery.

## NOTE

For additional information on POZZOLITH 300-R or on its use in developing a concrete mix with special performance characteristics, contact your local MBT field representative, or the Technical Services Department, MBT.

27/72

### Strand Properties

Strand type		13 mm (0.5")		15 mm (0.6")	
		EN138 or BS 5896 Super	ASTM A416 Grade 270	EN138 or BS 5896 Super	ASTM A416 Grade 270
Nominal diameter	mm	12.9	12.7	15.7	15.2
Nominal area	mm <sup>2</sup>	100	98.7	150	140
Nominal mass	kg/m	0.785	0.775	1.18	1.1
Yield strength	MPa	1580 <sup>1)</sup>	1670 <sup>2)</sup>	1500 <sup>1)</sup>	1670 <sup>2)</sup>
Tensile strength	MPa	1860	1860	1770	1860
Min. breaking load	kN	185	183.7	265	260.7
Young's modulus	GPa	circa 195			
Relaxation <sup>3)</sup>	%	max 2.5			

- 1) Measured at 0.1% residual strain (0.1% offset method)
- 2) Measured at 1% extension (1% extension under load method)
- 3) After 1000 hrs at 20° C (EN & BS, low relaxation to ASTM)

### Tendon Properties

STRAND TYPE 13 mm (0.5")					
Tendon unit	No. of strands	Duct ID/OD <sup>4)</sup>		Min. Breaking load (kN)	
		Min. (mm)	Nominal (mm)	12.9	12.7
5-4	2	36/39	36/39	372	367
	3			558	551
	4			744	735
5-7	5	51/54	51/54	930	919
	6			1116	1102
	7			1302	1286
5-12	8	60/67	60/67	1488	1470
	9			1674	1653
	10			1860	1837
	11			2046	2021
	12			2232	2204
5-19	13	75/82	80/87	2416	2388
	14			2604	2572
	15			2790	2756
	16			2976	2939
	17			3162	3123
	18			3348	3307
	19			3534	3480
5-22	20	80/87	95/102	3720	3674
	21			3806	3858
	22			4092	4041
5-27	23	95/102	100/107	4278	4225
	24			4464	4409
	25			4650	4593
	26			4836	4776
	27			5022	4960
5-31	28	95/102	100/107	5208	5144
	29			5394	5327
	30			5580	5511
	31			5766	5685
5-37	32	110/117	110/117	5952	5878
	33			6138	6062
	34			6324	6248
	35			6510	6430
	36			6696	6613
	37			6882	6797
5-42	38	120/127	120/127	7068	6981
	39			7254	7164
	40			7440	7348
	41			7626	7532
	42			7812	7715
5-48	43	130/137	130/137	7998	7899
	44			8184	8083
	45			8370	8267
	46			8556	8450
	47			8742	8634
	48			8928	8818
5-55	49	130/137	135/142	9114	9001
	50			9300	9185
	51			9486	9369
	52			9672	9552
	53			9858	9735
	54			10044	9920
	55			10230	10104

STRAND TYPE 15 mm (0.6")					
Tendon unit	No. of strands	Duct ID/OD <sup>4)</sup>		Min. Breaking load (kN)	
		Min. (mm)	Nominal (mm)	15.7	15.2
6-3	2	36/39	36/39	530	521
	3			795	782
	4			1060	1043
6-7	5	55/62	65/72	1325	1304
	6			1590	1564
	7			1855	1825
	8			2120	2086
6-12	9	75/82	80/87	2385	2346
	10			2650	2607
	11			2915	2868
	12			3180	3128
	13			3445	3388
6-19	14	90/97	100/107	3710	3650
	15			3975	3911
	16			4240	4171
	17			4505	4432
	18			4770	4693
	19			5035	4953
6-22	20	100/107	100/107	5300	5214
	21			5565	5475
	22			5830	5735
6-27	23	110/117	110/117	6095	5996
	24			6360	6257
	25			6625	6518
	26			6890	6778
	27			7155	7039
6-31	28	120/127	120/127	7420	7300
	29			7685	7560
	30			7950	7821
	31			8215	8082
6-37	32	130/137	130/137	8480	8342
	33			8745	8603
	34			9010	8864
	35			9275	9125
	36			9540	9385
6-42	37	135/142	135/142	9805	9646
	38			10070	9907
	39			10335	10167
	40			10600	10428
	41			10865	10689
	42			11130	10949
6-48	43	150/160	160/170	11395	11210
	44			11660	11471
	45			11925	11732
	46			12190	11992
	47			12455	12253
	48			12720	12514
6-55	49	160/170	170/180	12985	12774
	50			13250	13035
	51			13515	13296
	52			13780	13556
	53			14045	13817
	54			14310	14078
	55			14575	14339

4) Corrugated plastic PT-Plus™ ducts are also available, refer to page 11



28/73

MULTISTRAND POST-TENSIONING

Stressing Anchorage VSL Type EC

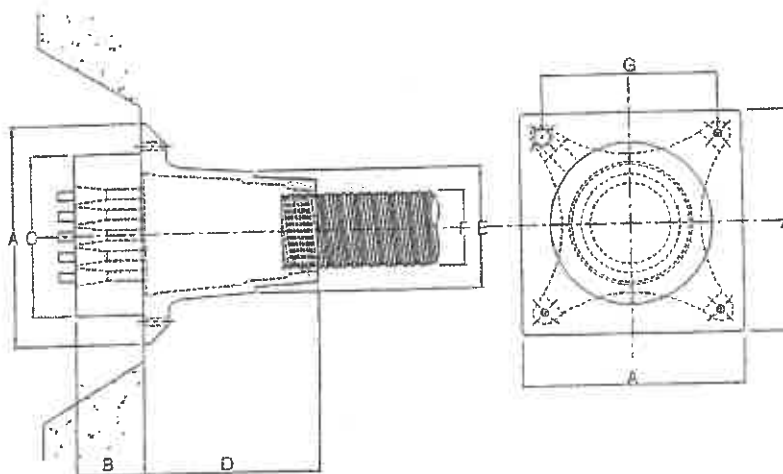
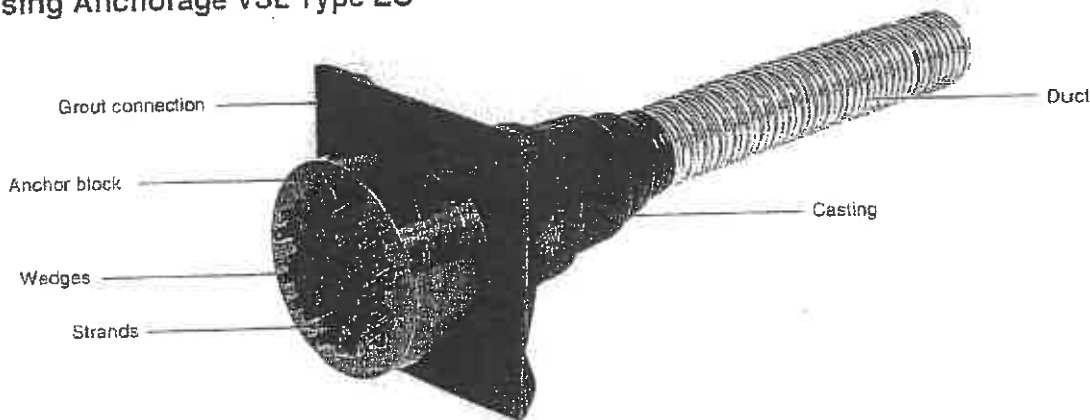

Tendon unit		Dimensions						
		A	B	C	D	E	F Ext. Dia.	G
Strand Type 13 mm (0.5")	5-4	135	60	85	100	58	39	95
	5-7	165	60	110	100	85	54	125
	5-12	215	60	150	160	120	72	150
	5-19	265	70	180	210	145	87	200
	5-22	290	77	200	215	150	102	230
	5-27	315	92	220	300	175	107	250
	5-31	315	100	230	300	175	107	250
	5-37	370	107	250	320	200	117	305
	5-42	390	112	290	340	217	127	325
	5-48	430	122	290	340	235	137	365
5-55	465	150	320	340	250	142	400	
Strand Type 15 mm (0.6")	6-3	135	60	90	100	58	39	95
	6-4	165	60	110	100	85	54	125
	6-7	215	60	150	160	120	72	150
	6-12	265	75	180	210	145	87	200
	6-19	315	92	220	300	175	107	250
	6-22	315	100	230	300	175	107	250
	6-27	370	112	250	320	200	117	305
	6-31	390	122	270	340	217	127	325
	6-37	430	142	300	340	235	137	365
	6-42	465	145	320	340	250	142	400

Subject to modification

Dimensions in mm  
 Dimensions are valid for:  
 Nominal concrete strength at 28 days: 35 MPa (cube), 28 MPa (cylinder).  
 Maximum prestressing force may be applied when concrete reaches 25 MPa (cube) or 20 MPa (cylinder).  
 Max prestressing force is 75% of min. tendon breaking load (temporary overspanning to 80%).

29/72

### Stressing

The unique feature of the VSL Post-Tensioning system lies in its special procedure for locking the wedges. The wedges always remain in contact with the strands during the stressing operation. As the pressure in the jack is released, the wedges automatically lock in the conical holes of the anchor head.

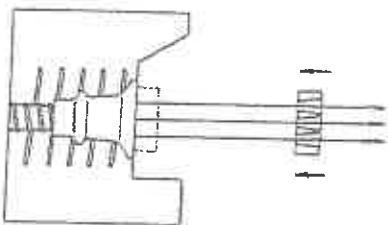

Placing of anchor block and wedges

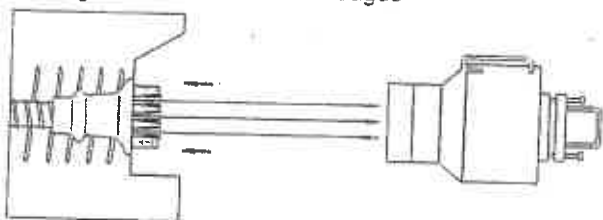

Positioning of the jack

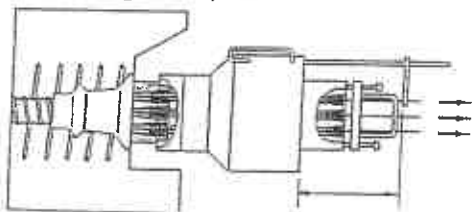

Stressing

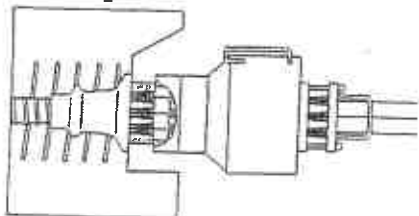

Seating of wedges

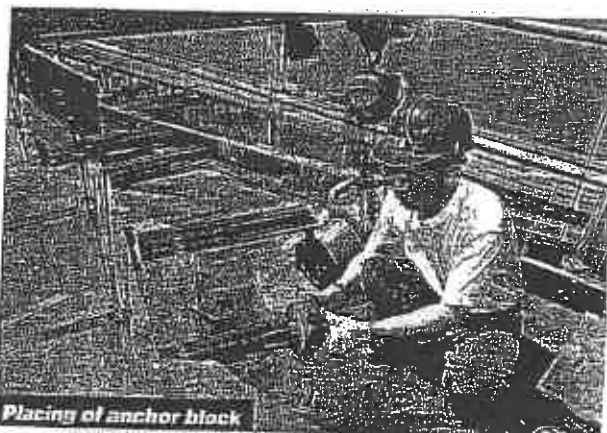

Placing of anchor block

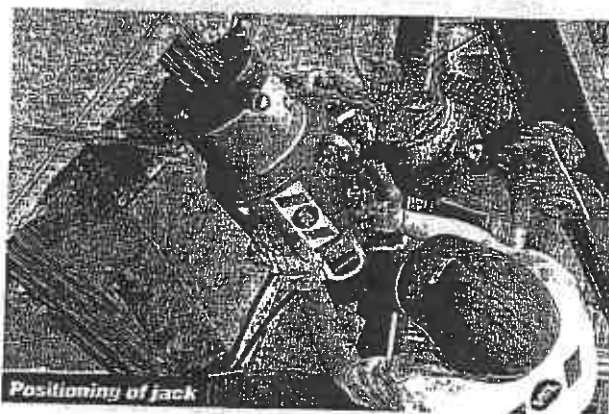

Positioning of jack

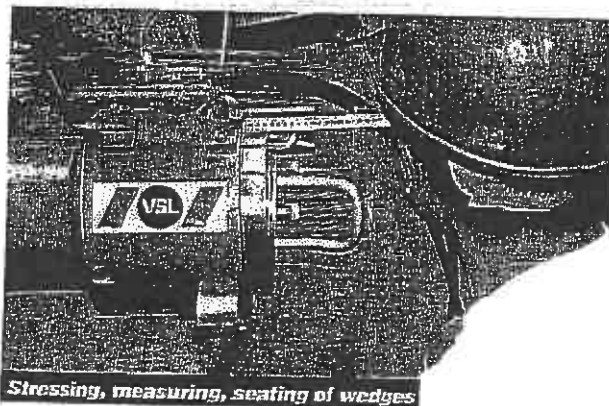

Stressing, measuring, seating of wedges

### Grouting

VSL grouting equipment includes mixer and pump in one unit. Grouting is usually carried out as soon as possible after stressing.

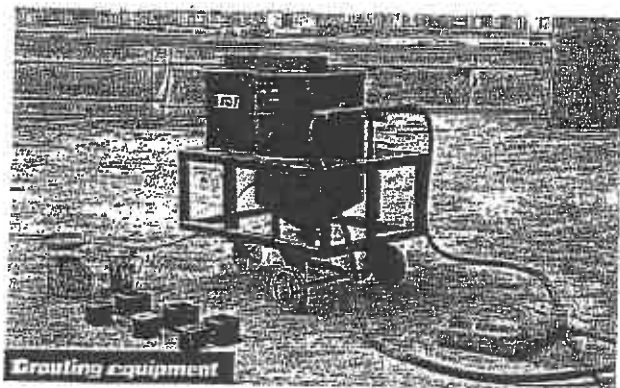

Grouting equipment

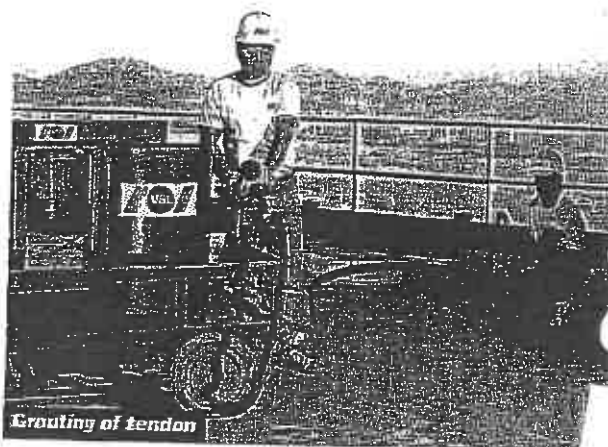

Grouting of tendon

30/73

Push Through Machine

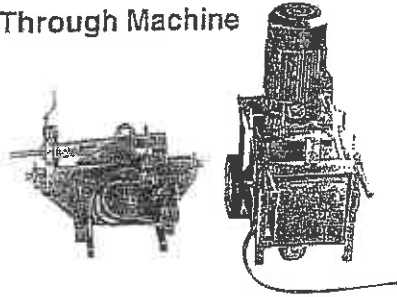

Hydraulic Pump

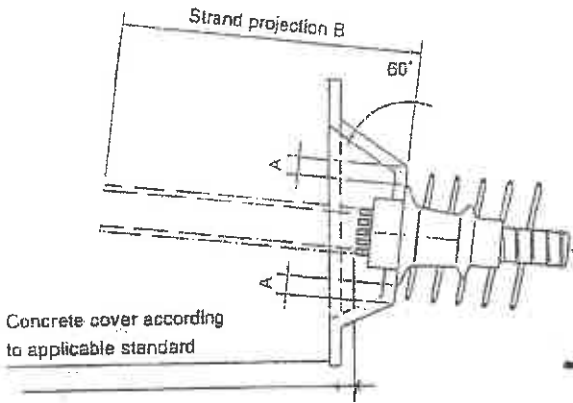

Jack type	A min.	B	C	D	E
ZPE-23FJ	-	300	1200	116	90
ZPE-30	30	600	1100	140	100
ZPE-3	30	550	1000	200	150
ZPE-60	30	650	1100	180	140
ZPE-7/A	30	800	1200	300	200
ZPE-12/S12	50	700	1300	310	200
ZPE-200	50	1100	2100	330	210
ZPE-19	50	850	1500	390	250
ZPE-460/31	60	700	1500	485	300
ZPE-500	80	1150	2000	585	330
ZPE-750	80	1350	2300	570	365
ZPE-1000	80	1300	2200	790	450
ZPE-1250	90	1350	2250	660	375

Dimensions in mm

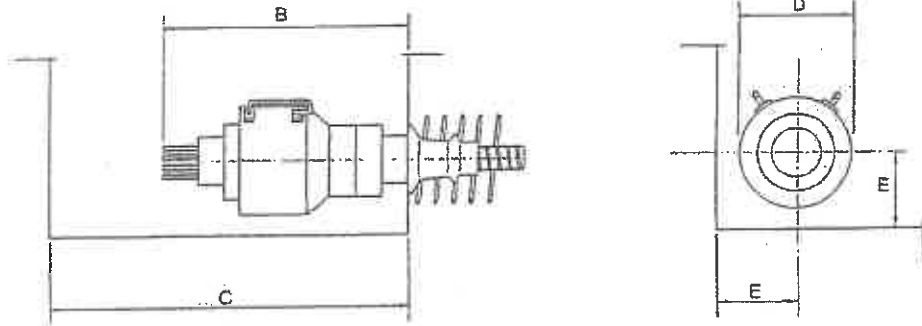

Stressing Jack Data

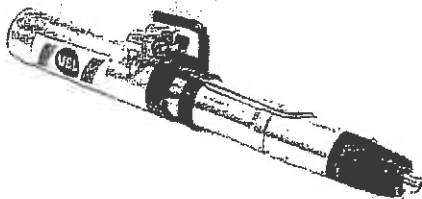

Type I (ZPE-23 FJ)



Type II (ZPE-19)

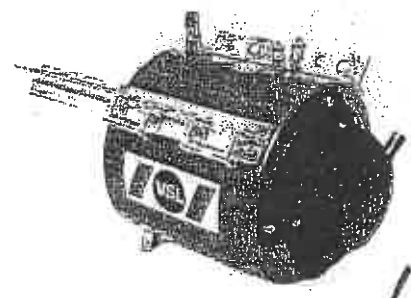

Type III (ZPE-500)

Designation	ZPE-23FJ	ZPE-30	ZPE-3	ZPE-60	ZPE-7/A	ZPE-12/S12	ZPE-200	ZPE-19	ZPE-460/31	ZPE-500	ZPE-750	ZPE-1000	ZPE-1250
Type	I	III	III	III	III	II	III	II	II	III	II	III	II
Length (mm)	790	720	475	615	690	550	960	750	580	1000	1185	1200	1290
Diameter (mm)	116	140	200	180	280	310	315	390	485	550	520	790	620
Stroke (mm)	200	250	160	250	160	100	300	100	100	200	150	200	150
Piston area (cm <sup>2</sup> )	47.10	58.32	103.6	126.4	203.6	309.4	325.7	500.3	804.0	884.6	1247.0	1809.5	2188.0
Capacity (kN)	230	320	500	632	1064	1850	2000	2900	4680	5000	7500	10000	12500
(bar)	488	549	483	500	523	598	614	580	580	558	601	553	577
Weight (kg)	23	26	47	74	115	151	305	294	436	1064	1100	2290	1730
Used for 13 mm (0.5") tendon types	5-1	5-1	5-2	5-2	5-6	5-12	5-12	5-18	5-22	5-22	5-31	5-37	5-37
			5-3	to 5-4	5-7			5-19	5-31	5-31	5-37	to 5-55	to 5-55
Used for 15 mm (0.6") tendon types	6-1	6-1	6-2	6-2	6-4	6-6	6-6	6-12	6-18	6-18	6-31	6-31	6-31
			6-3	6-3		6-7	6-7		6-19	to 6-22		to 6-43	to 6-55

Subject to modification

External post-tensioning is well suited to bridges due to the resulting economies in construction costs and the high degree of corrosion resistance provided by the system. External tendons are easy to inspect and can be replaced if necessary. They are ideal for strengthening existing structures and have a multitude of applications in addition to bridges.

#### VSL external tendons consist of:

- strand bundle;
- polyethylene duct;
- end and intermediate anchorages as well as tendon couplers;
- grouting compound.

External tendons, usually guided over deviation saddles, have many similarities to stay cables and permanent soil and rock anchors.

Detailed information about design and construction is given in the VSL publication "External Post-Tensioning".



#### VSL External Post-tensioning System Components

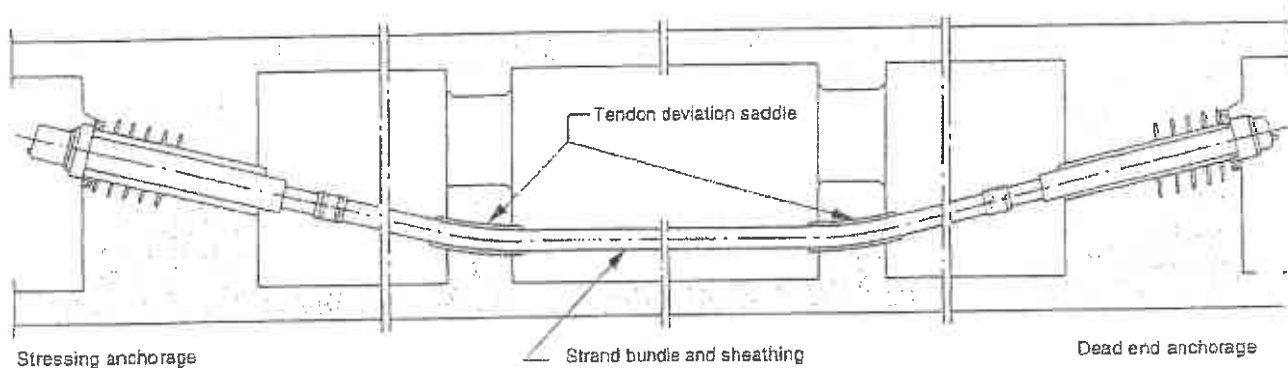



A wide selection of VSL anchorage types is available to meet the full range of practical requirements. In addition to the anchorages illustrated here, intermediate anchorages and couplers are also available. The strand bundle can be assembled from uncoated or individually greased and sheathed strands. The anchorages for these two types of tendon differ only in detail, the principle remains the same.

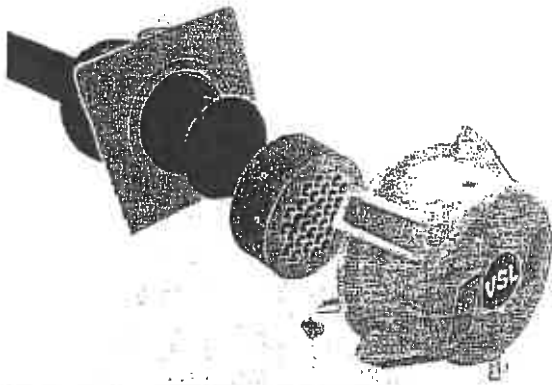

External prestressing components, Anchorage Type ECn

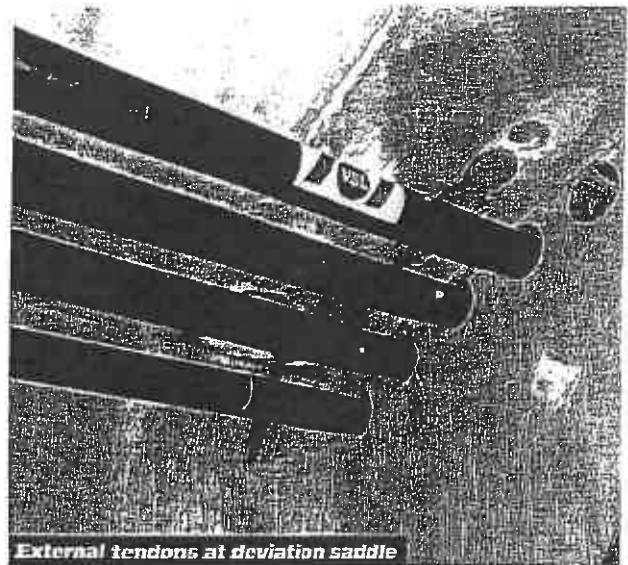

External tendons at deviation saddle

Tendon unit	Dimensions (mm)				
	□ A	B	∅C	D	∅E <sup>1</sup>
5-12	270	125	222	110	65 / 3.6
5-19	310	150	258	125	90 / 5.1
5-31	370	165	320	150	110 / 6.3
5-43	430	200	390	180	125 / 7.1
5-55	520	220	420	200	140 / 8.0
6-7	250	125	222	110	63 / 3.6
6-12	310	150	258	125	90 / 5.1
6-19	390	165	300	150	110 / 6.3
6-31	430	200	390	180	140 / 8.0
6-37	520	220	420	200	160 / 9.1

Notes : 1. Nominal external duct diameter / wall thickness  
 2. Other sizes are available upon request

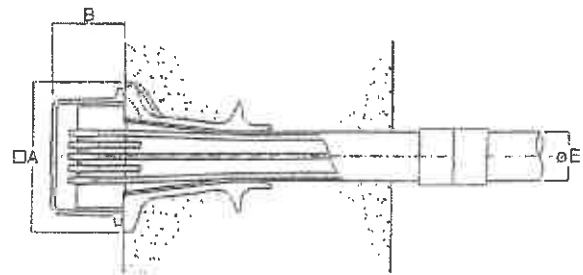

Anchorage Type ECn

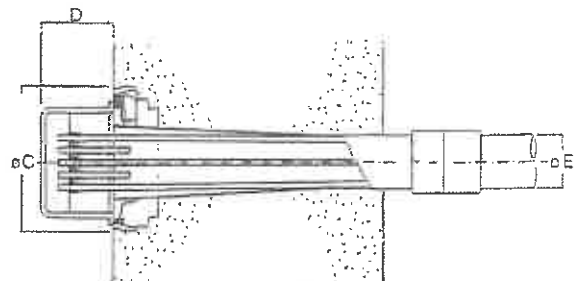

Anchorage Type CS

33/73

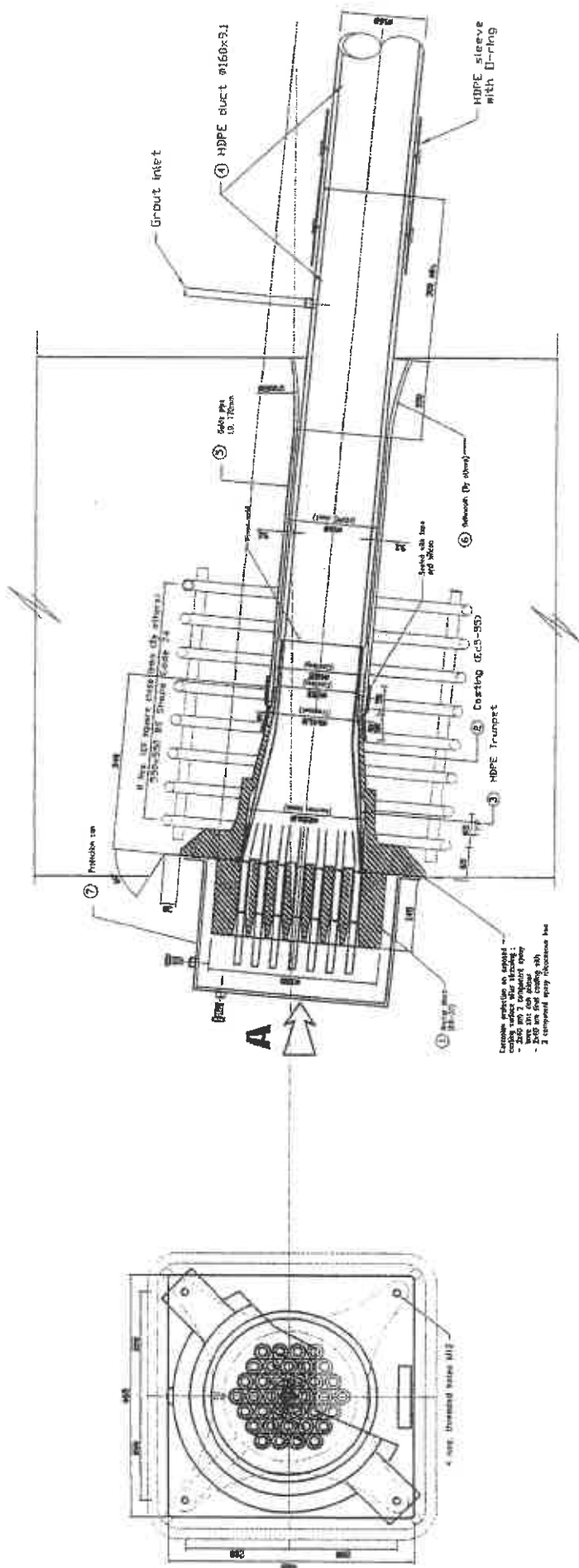

LONGITUDINAL - AFTER STRESSING

SCALE 1/12

VIEW A

Item	Qty.	Description
1	1	Anchor Block (E6-37)
2	1	Casting (E-SS5) MODIFIED
3	1	HDPE TRUMPET
4	-	HDPE DUCT DIA. 160 x 9.1 (PW6)
5	1	GUIDE PIPE OR VOID I.D. 170MM
7	1	BELLMOUTH
8	1	PROTECTION CAP

- Notes:
- Concrete strength at transfer 50N/mm
  - Primary anti-bursting reinforcement as shown to be provided by others

ANCHORAGE BLOCK HOLE PATTERN

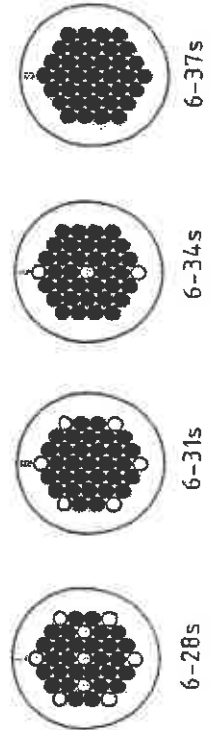

FOR INFORMATION ONLY

THIS DRAWING SHOULD BE READ IN CONJUNCTION WITH DOC NO: GSL/SWC/VSL/A/60/001 IN THE LATEST REVISION

TENDON FAMILY 6-37 IS USED FOR TENDON 6-28s, 6-31s, 6-34s, 6-37s

34/13

<p>VSL Vibrant Structures Ltd The Woodlands Drive, Suite 201 The Woodlands, NSW 2122</p>	<p>PROJECT</p> <p>Contract no. HY/2002/21 Hong Kong - Shenzhen Western Corridor</p>	<p>DRAWING TITLE</p> <p>VSL HONG KONG POST-TENSIONING SYSTEM ASSEMBLY DRAWING EXTERNAL TENDON 6-34, 6-37</p>	<p>SCALE</p> <p>AS SHOWN</p>	<p>REGION</p> <p>4</p>	<p>PAGE</p> <p>4/60/001</p>
		<p>DRAWING NUMBER</p> <p>GSL/SWC/VSL/</p>	<p>EXTERNAL TENDON 6-34, 6-37</p>	<p>DRAWING NUMBER</p> <p>GSL/SWC/VSL/</p>	<p>4/60/001</p>

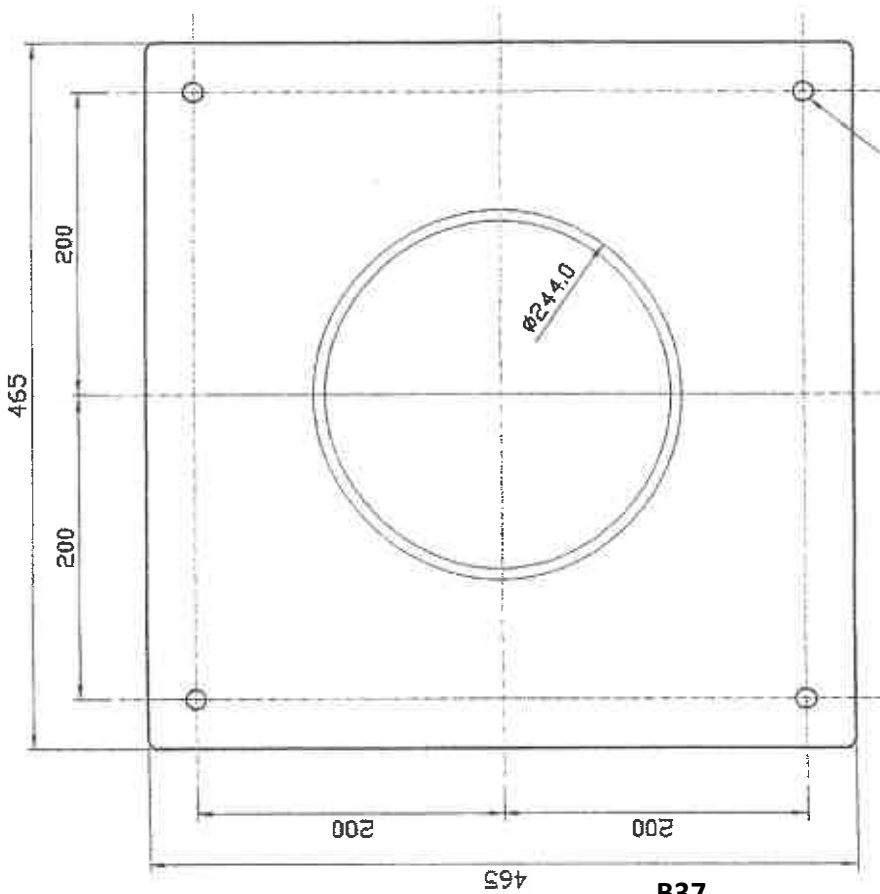

4 nos. threaded holes M12

VIEW A

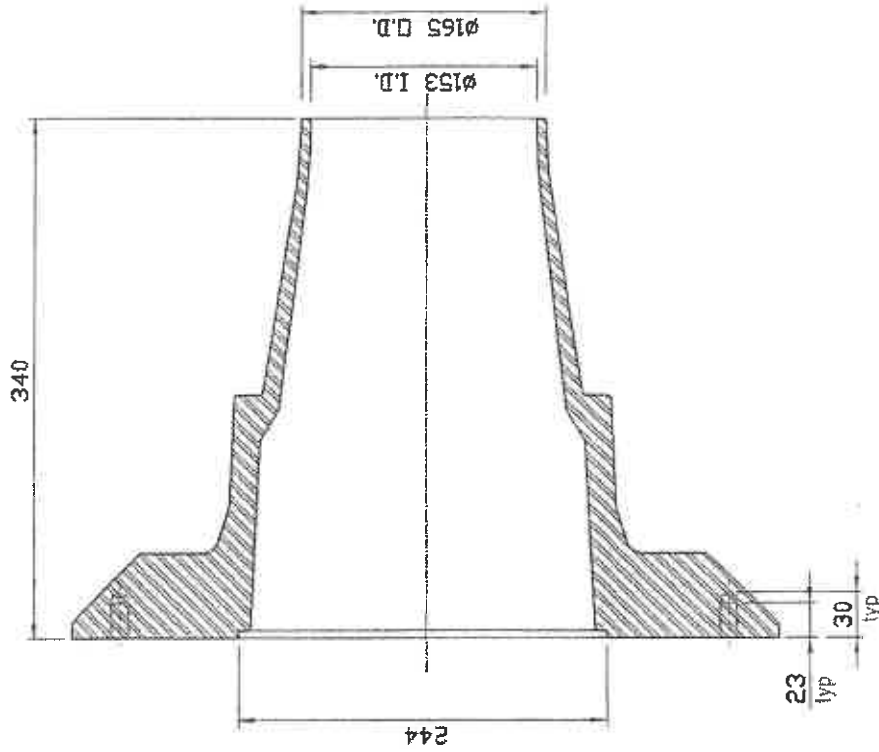

LONGITUDINAL VIEW

CASTING EC 5-555c FOR EXTERNAL  
TENDON 6-28s, 6-31s, 6-34s, 6-37s

metal casting tolerances U.N.O.  
1.0mm on dimensions up to 150mm  
1.5mm on dimensions from 151mm to 230mm  
2.3mm on dimensions over 230mm  
size to be fit within 1.5mm  
1 holes to be fit from burr.  
1 holes 3' unless otherwise specified  
1 all 5mm unless otherwise specified  
1 all steel 500-7 S.G. RW to AS 1031-1905

35/13

	PROJECT Contract no. HY/2002/21 Hong Kong - Shenzhen Western Corridor	VSL BV Vrije Universiteit Amsterdam Vrije Universiteit 1000 Leiden, The Netherlands	DRAWING TITLE VSL HONG KONG POST-TENSIONING SYSTEM ASSEMBLY DRAWING EXTERNAL TENDON 6-31, 6-34, 6-37	SCALE 1:5 DRAWING NUMBER GSI/SWC/VSL/	REVISION # 15	PAGE 7/6
	ARUP		DATE 01/11/03	DRAWING NUMBER GSI/SWC/VSL/	DATE 4/60/001	

- FOR DESIGN AND CONSTRUCTION OF PIERCE, REFER TO THE DRAWING NUMBER 33511/06/51-011
- THIS DRAWING SHOULD BE USED IN CONJUNCTION WITH AND, NO. 33511/06/51-025
- STAKE NUMBERS FOR TENDER REPLACEMENT ARE NOT SHOWN FOR CLARITY.
- ALL EXTERNAL STRENGTH SHALL BE COMPLIED WITH AS PER THE REQUIREMENTS OF THE SPECIFICATION FOR PRESTRESSING REFER TO NO. 33511/06/51-011.

LEGEND



SECRET NUMBER 33511-211



ISSUE FOR APPROVAL/ISSUE	DATE	BY	DATE

Contract  
**ARUP** 奧雅納工程顧問  
 Supervised By: 劉國強  
 Design Engineer: 劉國強  
 Design Checker: 劉國強  
 Project No. HY2002/21  
 Hong Kong-Sheraton Western Corridor

Contract No. HY2002/21  
 Hong Kong-Sheraton Western Corridor

Working No.

APPROACH VIADUCT  
 EXTERNAL PRESTRESSING

1 SHEET ( OF 5 )

DATE	NO.	DESCRIPTION
23/11/06	01	ISSUED FOR TENDER
23/11/06	02	ISSUED FOR TENDER
23/11/06	03	ISSUED FOR TENDER

COMMITMENT RESERVED  
 香港公路局  
 HIGHWAYS DEPARTMENT  
 Major Works Project Management Office

Appendix B

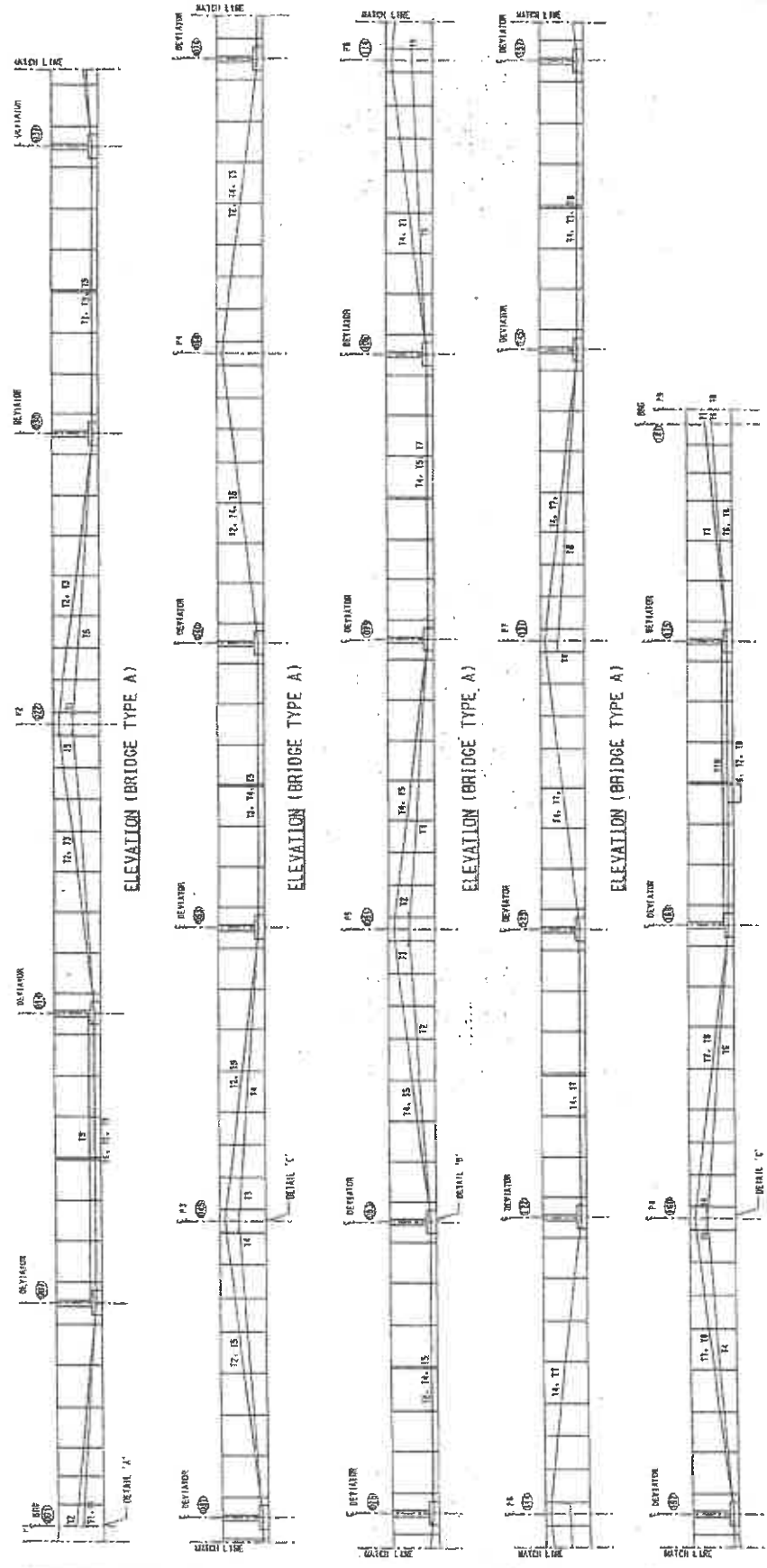

PIER REFERENCE

PIER NO.	PIER REF.	PIER NO.	PIER REF.	PIER NO.	PIER REF.
P1	11	P2	12	P3	13
P1	14	P2	15	P3	16
P1	17	P2	18	P3	19
P1	20	P2	21	P3	22
P1	23	P2	24	P3	25
P1	26	P2	27	P3	28
P1	29	P2	30	P3	31
P1	32	P2	33	P3	34
P1	35	P2	36	P3	37
P1	38	P2	39	P3	40
P1	41	P2	42	P3	43
P1	44	P2	45	P3	46
P1	47	P2	48	P3	49
P1	50	P2	51	P3	52
P1	53	P2	54	P3	55
P1	56	P2	57	P3	58
P1	59	P2	60	P3	61
P1	62	P2	63	P3	64
P1	65	P2	66	P3	67
P1	68	P2	69	P3	70
P1	71	P2	72	P3	73
P1	74	P2	75	P3	76
P1	77	P2	78	P3	79
P1	80	P2	81	P3	82
P1	83	P2	84	P3	85
P1	86	P2	87	P3	88
P1	89	P2	90	P3	91
P1	92	P2	93	P3	94
P1	95	P2	96	P3	97
P1	98	P2	99	P3	100

STRESSING AND FORCE (KN) SCHEDULE

PIER NO.	PIER REF.	STRESSING AND FORCE (KN)
P1	11	11
P1	14	14
P1	17	17
P1	20	20
P1	23	23
P1	26	26
P1	29	29
P1	32	32
P1	35	35
P1	38	38
P1	41	41
P1	44	44
P1	47	47
P1	50	50
P1	53	53
P1	56	56
P1	59	59
P1	62	62
P1	65	65
P1	68	68
P1	71	71
P1	74	74
P1	77	77
P1	80	80
P1	83	83
P1	86	86
P1	89	89
P1	92	92
P1	95	95
P1	98	98
P1	101	101

ELEVATION CONTROL POINT SCHEDULE FOR EXTERNAL TENDONS OF BRIDGE TYPE A

36/73

Proj. No. 2351/06/621-235

LEGEND

REVISION NUMBER (DETAIL 2/2)

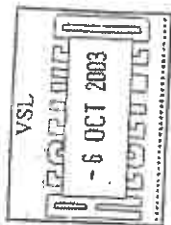

Rev	Description	By	Date

Contracted By: 廣聯精工建築有限公司  
 ARUP Overseas & Pacific Hong Kong Limited  
 Supported By: 香港房屋委員會  
 Consulting Engineer: 怡和洋行  
 2351 Group Ltd  
 2351 Main Pacific Ltd  
 Project No.

Contract No. HY2002/21  
 Hong Kong-Sheenzhen Western Corridor

Priority 6/6  
 APPROACH VIADUCT  
 EXTERNAL PRESTRESSING

Drawing No.	2351/06/622	Scale	1:1
Project No.	2351	Sheet No.	2 OF 6
Drawn By		Checked By	
Issue No.	1.1.1	Norming	

香港房屋委員會  
 HIGHWAYS DEPARTMENT  
 Major Works Project Management Office

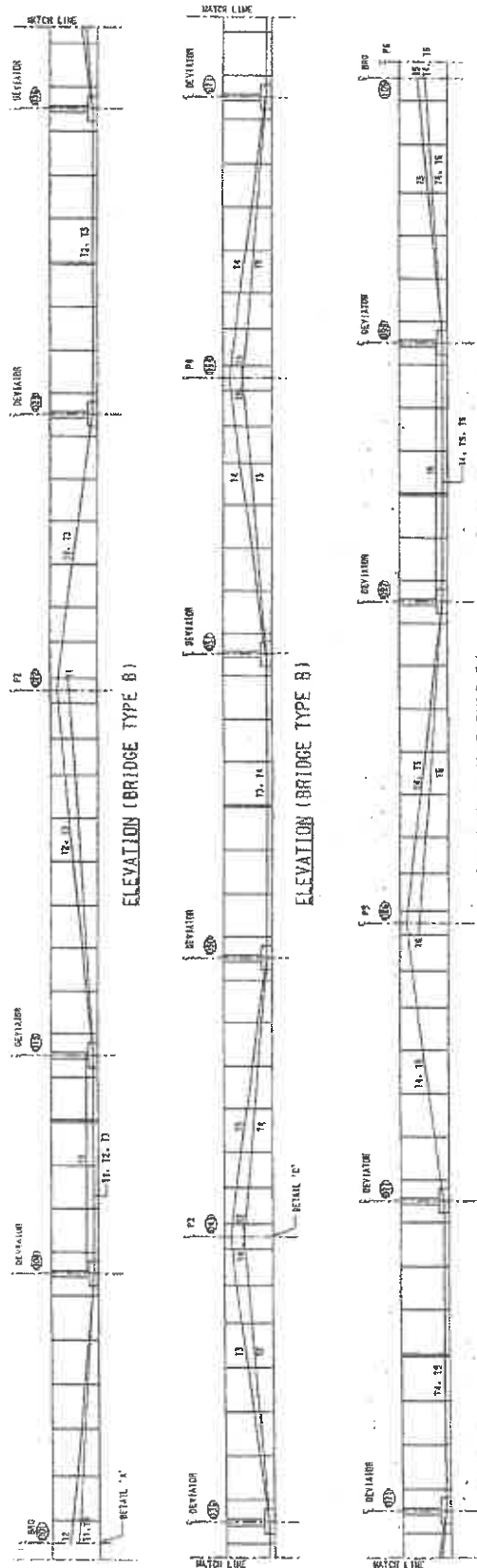

PIER	NO.	TYPE	NO. OF TENDONS	STRESSING POSITION	STRESSING DATE	STRESSING VALUE	STRESSING METHOD
1	1	PIER	1	1	1	1	1
2	2	PIER	2	2	2	2	2
3	3	PIER	3	3	3	3	3
4	4	PIER	4	4	4	4	4
5	5	PIER	5	5	5	5	5
6	6	PIER	6	6	6	6	6
7	7	PIER	7	7	7	7	7
8	8	PIER	8	8	8	8	8
9	9	PIER	9	9	9	9	9
10	10	PIER	10	10	10	10	10
11	11	PIER	11	11	11	11	11
12	12	PIER	12	12	12	12	12
13	13	PIER	13	13	13	13	13
14	14	PIER	14	14	14	14	14
15	15	PIER	15	15	15	15	15
16	16	PIER	16	16	16	16	16
17	17	PIER	17	17	17	17	17
18	18	PIER	18	18	18	18	18
19	19	PIER	19	19	19	19	19
20	20	PIER	20	20	20	20	20
21	21	PIER	21	21	21	21	21
22	22	PIER	22	22	22	22	22
23	23	PIER	23	23	23	23	23
24	24	PIER	24	24	24	24	24
25	25	PIER	25	25	25	25	25
26	26	PIER	26	26	26	26	26
27	27	PIER	27	27	27	27	27
28	28	PIER	28	28	28	28	28
29	29	PIER	29	29	29	29	29
30	30	PIER	30	30	30	30	30

PIER REFERENCE

TENDON CONTROL POINT SCHEDULE FOR EXTERNAL TENDONS OF BRIDGE TYPE B

37/73



FIG. NO. D3110/021-425.  
 1. DETAILS OF CABLE SETTING OUT ARE TO BE PROVIDED IN SEPARATE SCHEDULE.

**LEGEND**

- + TENDON CONTROL POINTS
- M/V CONTROL POINT NUMBER
- SECURITY TYPE



No.	Description	CS	DT/DA	By	Date
<b>ARUP</b> 廣 德 柏 工 程 有 限 公 司 2004 Limited By / 2004 年 有 限 公 司 Chief Consulting Engineer 0 Usha Lila Chief Engineer 0 D Gireesh & Praveen BVT 000 0000 1/07 D					
Project Title					

Contract No. HY/2002/21  
 Hong Kong-Shenzhen Western Corridor

Drawing No.  
**APPROACH VIADUCT**  
**EXTERNAL PRESTRESSING**

23511/06/624	
DATE	2006 JUN 05
SCALE	1:100
PROJECT	GOVERNMENT ROADWORK
DESIGNER	ARUP
CHECKER	ARUP
APPROVED	ARUP

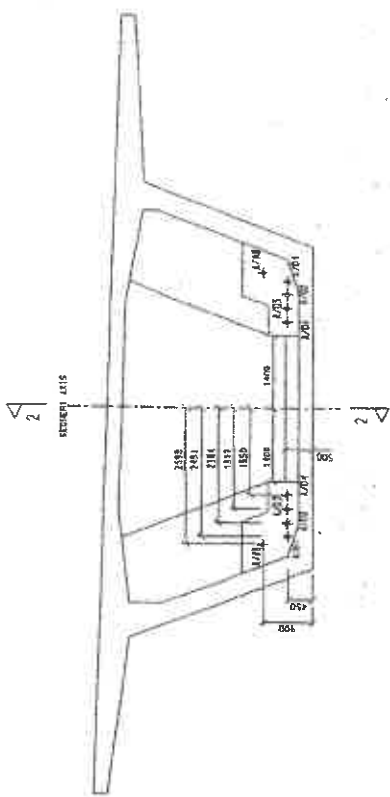
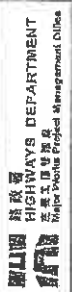

CONTROL POINTS FOR DEVIATOR TUBES IN SEGMENTS WITH SPANS

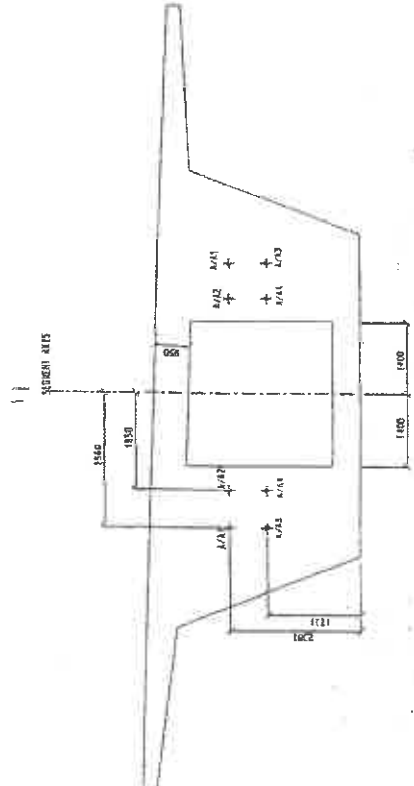
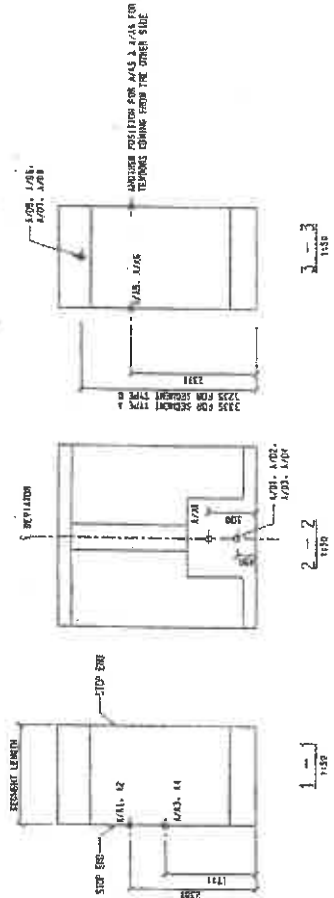

CONTROL POINTS FOR ANCHORAGES IN SEGMENTS AT ENDS OF DECK

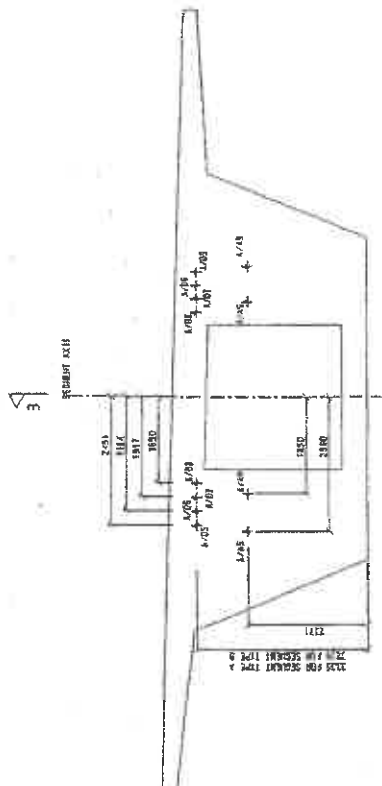

CONTROL POINTS FOR ANCHORAGES IN SEGMENTS AT INTERNAL PIERS

39/73

2. THE LATEL CENTER-LINE OF EACH STRAND, BEFORE AND AFTER STRESSING, SHOULD BE MAINTAINED AS NEARLY AS POSSIBLE TO THE ORIGINAL POSITION. THE STRANDS SHOULD BE PASSED THROUGH THE TUBES FROM ONE END TO THE OTHER WITHOUT BEING BENT OR DAMAGED. THE STRANDS SHOULD BE KEPT STRAIGHT AND THE TUBES SHOULD BE KEPT STRAIGHT THROUGHOUT THE LENGTH OF THE TENDON. THE TUBES SHOULD BE KEPT STRAIGHT THROUGHOUT THE LENGTH OF THE TENDON. THE TUBES SHOULD BE KEPT STRAIGHT THROUGHOUT THE LENGTH OF THE TENDON.
3. THE TUBES AND ANCHORAGE ASSEMBLY SHALL BE KEPT STRAIGHT THROUGHOUT THE LENGTH OF THE TENDON. THE TUBES AND ANCHORAGE ASSEMBLY SHALL BE KEPT STRAIGHT THROUGHOUT THE LENGTH OF THE TENDON. THE TUBES AND ANCHORAGE ASSEMBLY SHALL BE KEPT STRAIGHT THROUGHOUT THE LENGTH OF THE TENDON.
4. THE TUBES AND ANCHORAGE ASSEMBLY SHALL BE KEPT STRAIGHT THROUGHOUT THE LENGTH OF THE TENDON. THE TUBES AND ANCHORAGE ASSEMBLY SHALL BE KEPT STRAIGHT THROUGHOUT THE LENGTH OF THE TENDON. THE TUBES AND ANCHORAGE ASSEMBLY SHALL BE KEPT STRAIGHT THROUGHOUT THE LENGTH OF THE TENDON.
5. THE TUBES AND ANCHORAGE ASSEMBLY SHALL BE KEPT STRAIGHT THROUGHOUT THE LENGTH OF THE TENDON. THE TUBES AND ANCHORAGE ASSEMBLY SHALL BE KEPT STRAIGHT THROUGHOUT THE LENGTH OF THE TENDON. THE TUBES AND ANCHORAGE ASSEMBLY SHALL BE KEPT STRAIGHT THROUGHOUT THE LENGTH OF THE TENDON.

Rev	Description	By	Date
1	ISSUE FOR CONSTRUCTION	BY	07/05

**ARUP** 奥雅工程顾问有限公司  
 Supported By:  
 CH2M Consulting Engineers  
 88 Bruce Ltd  
 BM/ Able Traffic Ltd  
 P-1000 Bm

Contract No. HY2002/21  
 Hong Kong-Shenzhen Western Corridor

APPROACH VJ ADUCT  
 EXTERNAL PRESTRESSING

SHEET 5 OF 5  
 23511/06/5/35  
 1:10

HIGHWAYS DEPARTMENT  
 Major Works Project Management Office

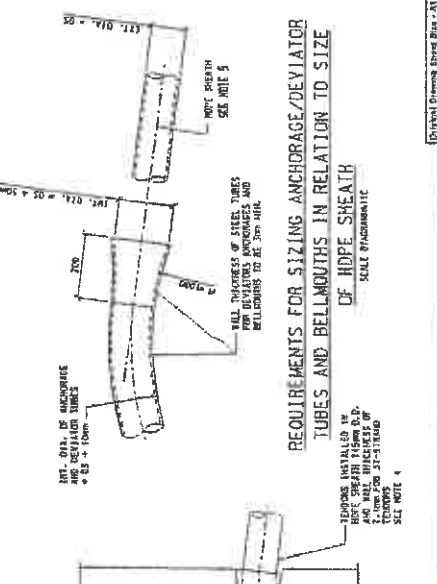
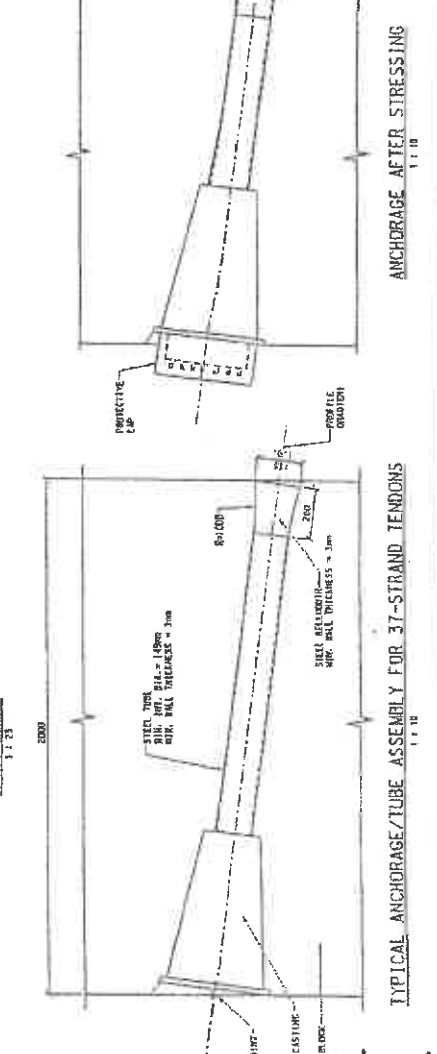
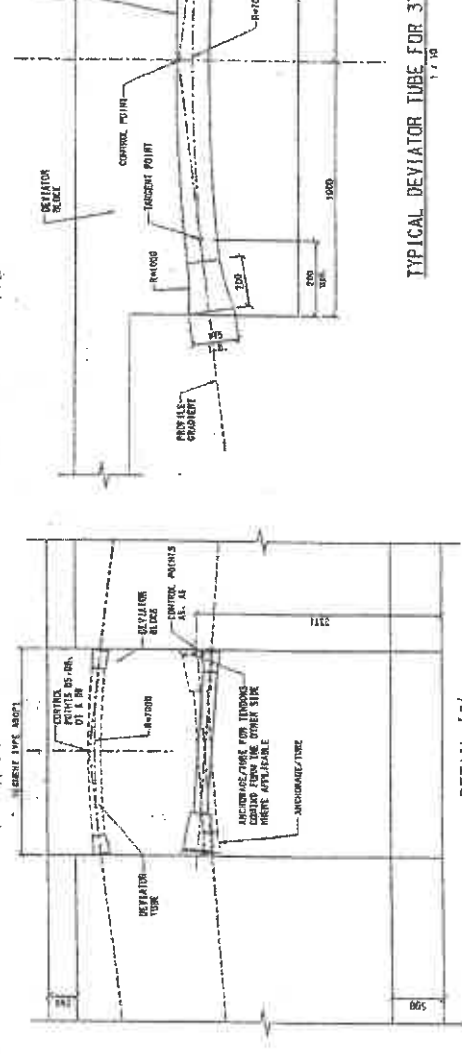
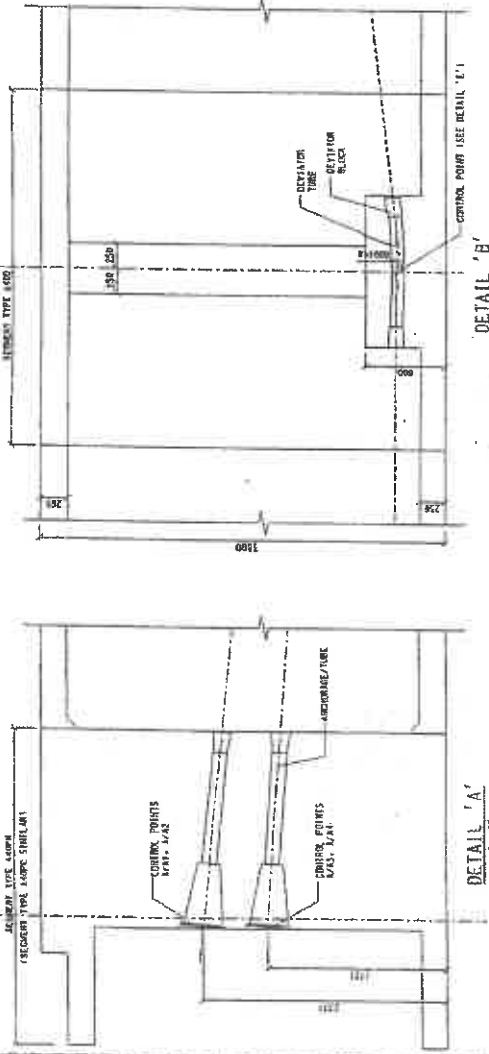
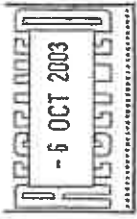

**REQUIREMENTS FOR SIZING ANCHORAGE/DEVIATOR TUBES AND BELLMOUTHS IN RELATION TO SIZE OF HOPE SHEATH**  
 ALL THICKNESS OF STEEL TUBES FOR DEVIATOR ANCHORAGES AND BELLMOUTHS TO BE 3mm MIN.

TENDONS INSTALLED IN HOPE SHEATH SHALL BE KEPT STRAIGHT THROUGHOUT THE LENGTH OF THE TENDON.

40/73



**Appendix C –**  
**List of Highway Bridges with External Prestressing Tendons**

### List of Bridges with External Prestressing Tendons

Location No.	Location	Year of Opening	No. of Tendon	No. of Tendon Exceeding 200m long
1	Tsing Yi Bridge 青衣大橋	1989	35	0
2	Rambler Channel Bridge 藍巴勒海峽大橋	1997	190	24
3	Cheung Tsing Viaduct 長青高架路	1997	72	0
4	Tsing Long Highway (across Kam Tin River and near Pok Oi Interchange) 青朗公路 (橫跨錦田河及近博愛迴旋處)	1998	254	0
5	Hung Hom Bypass 紅磡繞道	1999	626	0
6	Kwai Tsing Bridge 葵青橋	1999	440	0
7	Tsing Yi North Coastal Road 青衣北岸公路	2002	604	0
8	Penny's Bay Highway (near Inspiration Lake Recreation Centre) 竹篙灣公路 (近迪欣湖活動中心一段高架路)	2005	270	0
9	Kong Sham Western Highway 港深西部公路	2007	2074	16
10	Shenzhen Bay Bridge (Hong Kong Section) (Concrete Viaduct) 深圳灣大橋 香港段 (混凝土高架段)	2007	192	72
11	Tsing Sha Highway (Section b/t Mei Tin Road and Shing Chuen Road and near Chik Wan Street) 青沙公路 (美田路至成全路及近積運街之高架路)	2008	292	0
12	Lai Chi Kok Viaduct (Tsing Sha Highway) 荔枝角高架路 (青沙公路)	2008	270	0
13	Tai Wai Tunnel Approaches (Tsing Sha Highway) 大圍高架路 (青沙公路)	2008	52	0
14	East Tsing Yi Viaduct (Tsing Sha Highway) 青衣東高架路 (青沙公路)	2009	252	110
15	West Tsing Yi Viaduct (Tsing Sha Highway) 青衣西高架路 (青沙公路)	2009	26	16

## Appendix C

Location No.	Location	Year of Opening	No. of Tendon	No. of Tendon Exceeding 200m long
16	Ngong Sheun Chau Viaduct (Tsing Sha Highway) 昂船洲高架路 (青沙公路)	2009	258	186
17	Stonecutter Bridge (Concrete Deck) (Tsing Sha Highway) 昂船洲大橋 (混凝土橋段) (青沙公路)	2009	82	6
18	Flyover at Choi Ha Road 彩霞道連接天橋	2009	28	0
19	Hong Kong-Zhuhai-Macao Bridge Hong Kong Link Road 港珠澳大橋香港連接路	2018	778	208
20	Hong Kong-Zhuhai-Macao Bridge Hong Kong Port 港珠澳大橋香港口岸	2018	326	0
21	Chek Lap Lok Road 赤鱸角路	2018	34	0
22	TMCKL - Southern Connection 屯門至赤鱸角連接路南面連接路	2018	518	60
<b>Total</b>			<b>7673</b>	<b>698</b>