

WIL/G03/0001/3
DRAWING NO.

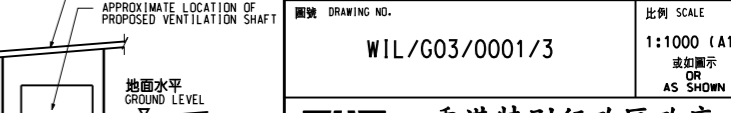
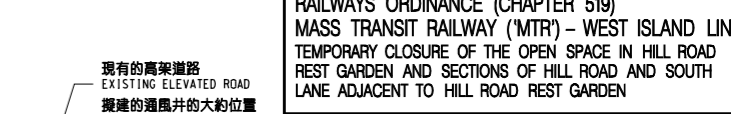
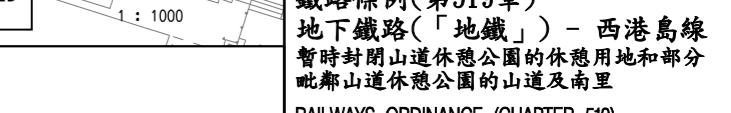
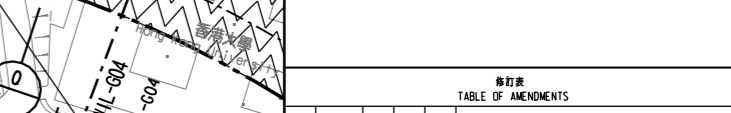
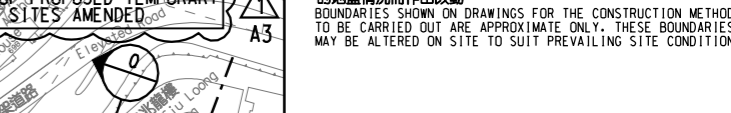
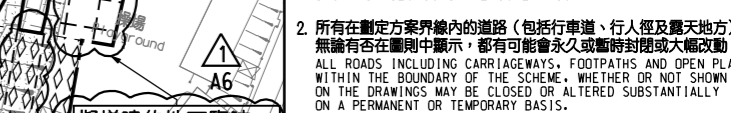
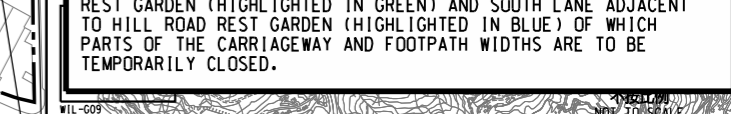
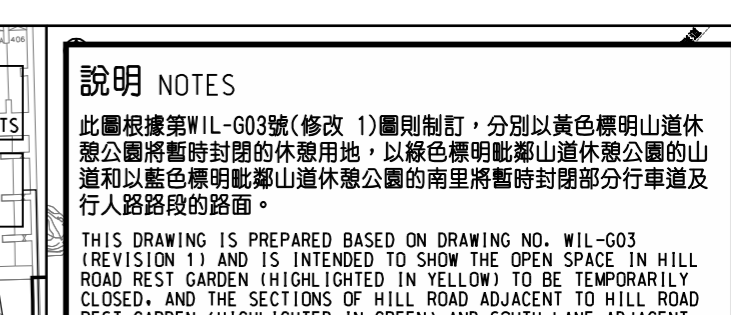
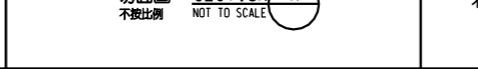
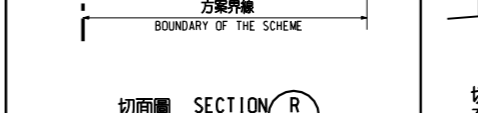
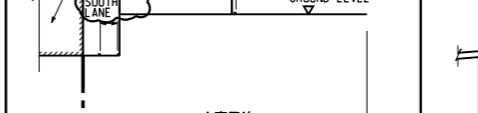
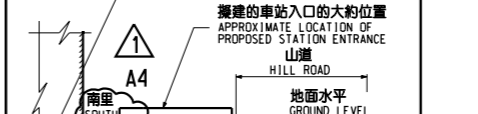
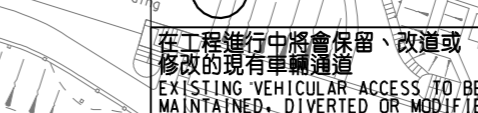
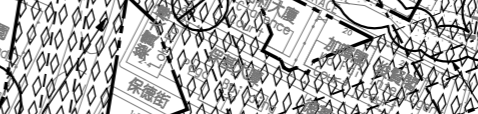
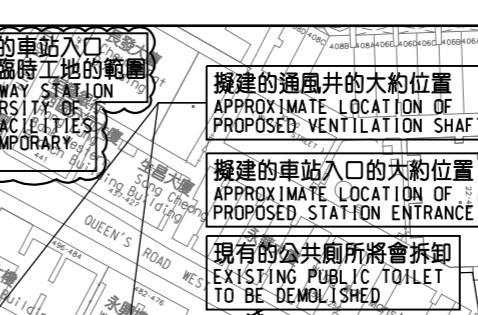
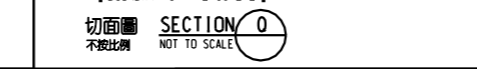
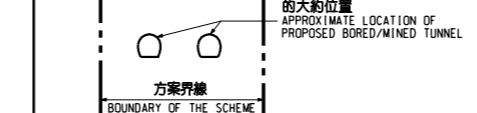
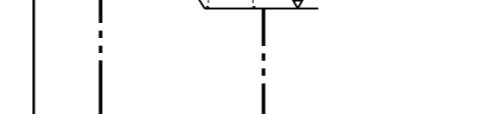
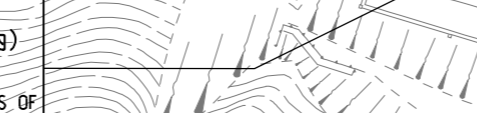
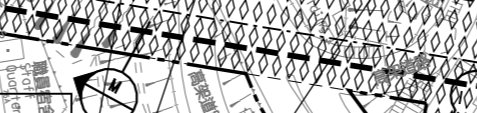
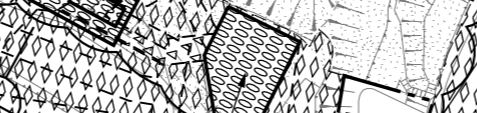
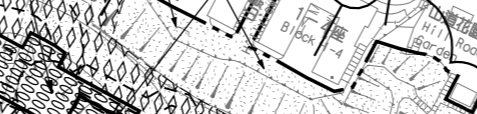
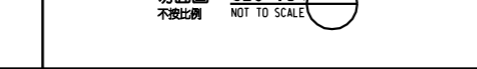
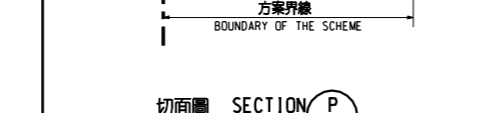
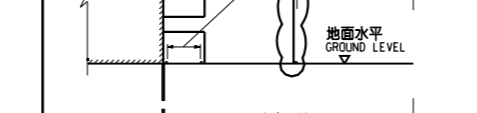
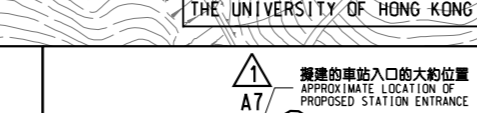
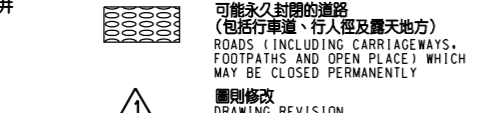
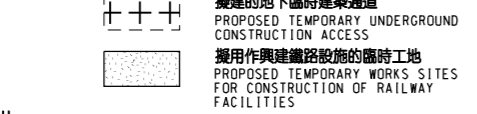
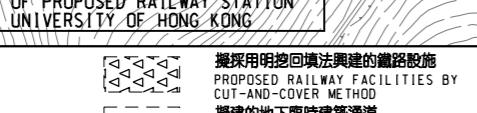
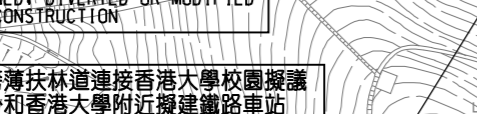
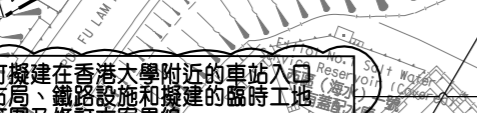
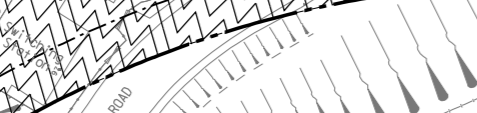
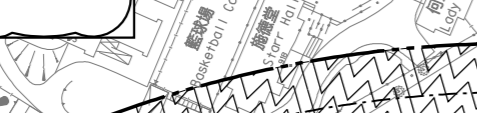
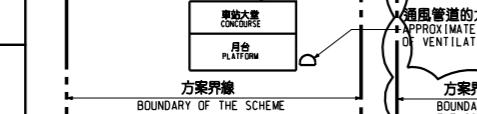
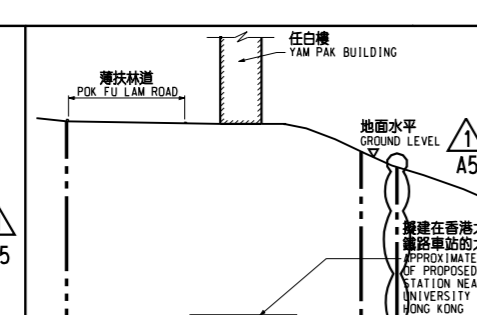
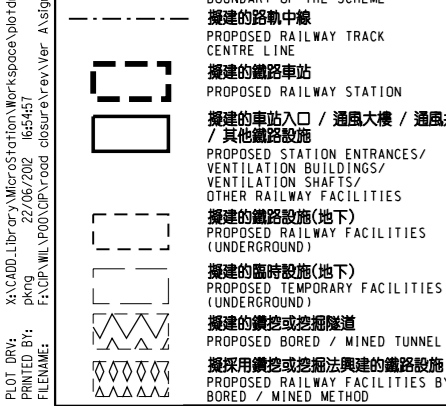
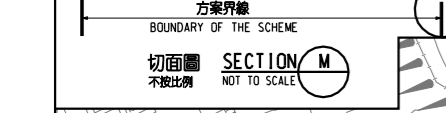
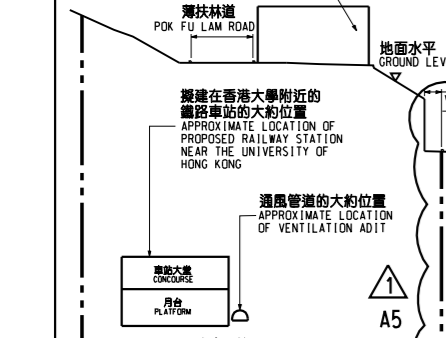
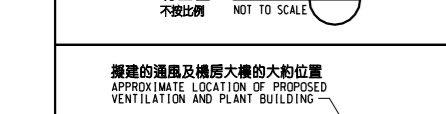
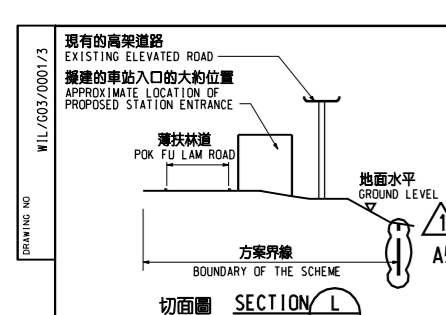

說明 NOTES

此圖根據第WIL-G03號(修改 1)圖則制訂,分別以黃色標明山道休憩公園將暫時封閉的休憩用地,以綠色標明毗鄰山道休憩公園的山道和以藍色標明毗鄰山道休憩公園的南里將暫時封閉部分車道及行人路路面的路面。

THIS DRAWING IS PREPARED BASED ON DRAWING NO. WIL-G03 (REVISION 1) AND IS INTENDED TO SHOW THE OPEN SPACE IN HILL ROAD REST GARDEN (HIGHLIGHTED IN YELLOW) TO BE TEMPORARILY CLOSED, AND THE SECTIONS OF HILL ROAD ADJACENT TO HILL ROAD REST GARDEN (HIGHLIGHTED IN GREEN) AND SOUTH LANE ADJACENT TO HILL ROAD REST GARDEN (HIGHLIGHTED IN BLUE) OF WHICH PARTS OF THE CARRIAGEWAY AND FOOTPATH WIDTHS ARE TO BE TEMPORARILY CLOSED.

一般說明 GENERAL NOTES

1. 切面圖所示鐵路設施的形狀和輪廓均屬示意性質。GEOMETRY AND CONFIGURATION OF RAILWAY FACILITIES SHOWN IN SECTIONS ARE SCHEMATIC.
2. 所有在劃定方案界線內的道路(包括行車道、行人徑及露天地方),無論有否在圖則中顯示,都有可能永久或暫時封閉或大幅改動。ALL ROADS INCLUDING CARRIAGEWAYS, FOOTPATHS AND OPEN PLACE WITHIN THE BOUNDARY OF THE SCHEME, WHETHER OR NOT SHOWN ON THE DRAWINGS MAY BE CLOSED OR ALTERED SUBSTANTIALLY ON A PERMANENT OR TEMPORARY BASIS.
3. 除非圖則中特別註明,否則在方案界線內,或與方案界線毗鄰的所有建築物的汽車通道及行人通道,包括逃生路徑,將會保留。UNLESS NOTED OTHERWISE ON THE DRAWINGS, VEHICULAR AND PEDESTRIAN ACCESSES INCLUDING MEANS OF ESCAPE TO AND FROM ALL BUILDINGS WITHIN OR ADJACENT TO THE BOUNDARY OF THE SCHEME ARE TO BE MAINTAINED.
4. 所有水平均為約數,以米為單位,並高於香港的主水平基準。ALL LEVELS ARE APPROXIMATE AND IN METRES ABOVE HONG KONG PRINCIPAL DATUM (MPD).
5. 圖則顯示的建造方法分界線只是大概位置,有關界線可因應當時的地盤情況而作出改動。BOUNDARIES SHOWN ON DRAWINGS FOR THE CONSTRUCTION METHODS TO BE CARRIED OUT ARE APPROXIMATE ONLY. THESE BOUNDARIES MAY BE ALTERED ON SITE TO SUIT PREVAILING SITE CONDITIONS.

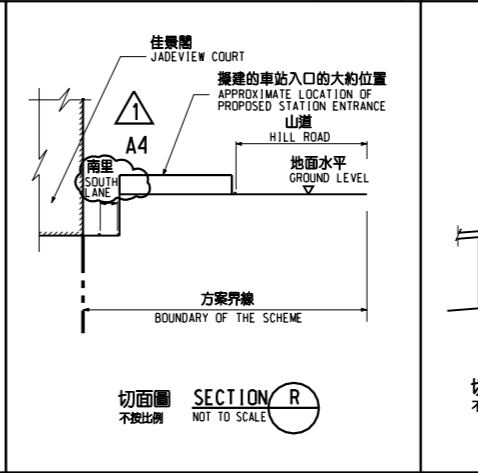
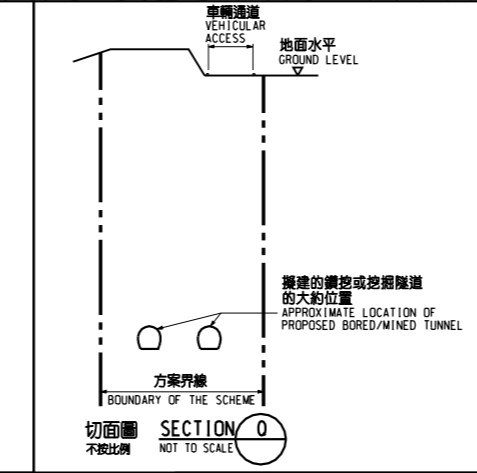
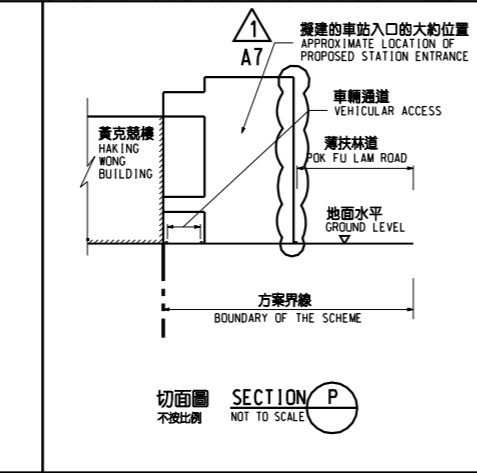
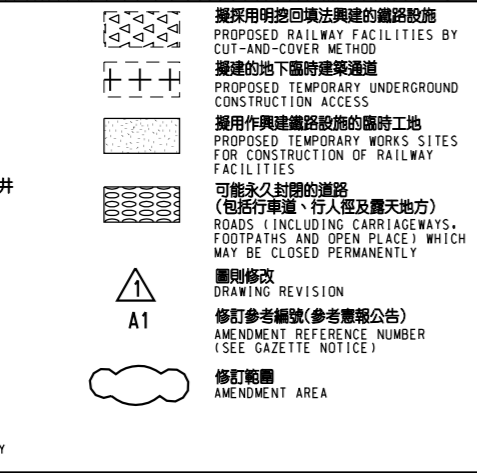
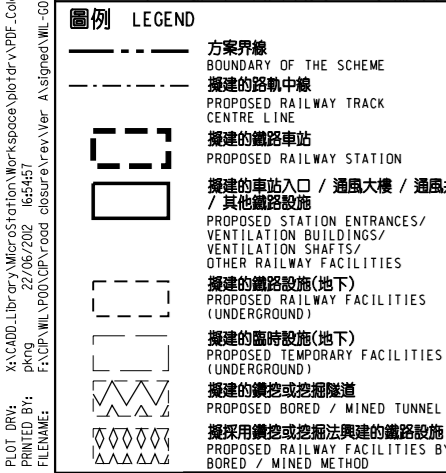

修訂表 TABLE OF AMENDMENTS

修訂日期	修訂人	修訂原因	說明
REV	DATE	BY	DESCRIPTION

SIGNED: 李大鈞 LEE TAI KWAN
 鐵路發展處工程師(2-1)
 CHIEF ENGINEER
 RAILWAY DEVELOPMENT (2-1)
 HIGHWAYS DEPARTMENT

21/6/2012
 發出日期 DATE OF ISSUE

圖則名稱 DRAWING TITLE
鐵路條例(第519章)
地下鐵路(「地鐵」) - 西港島線
 暫時封閉山道休憩公園的休憩用地和部分毗鄰山道休憩公園的山道及南里
 RAILWAYS ORDINANCE (CHAPTER 519)
 MASS TRANSIT RAILWAY (MTR) - WEST ISLAND LINE
 TEMPORARY CLOSURE OF THE OPEN SPACE IN HILL ROAD REST GARDEN AND SECTIONS OF HILL ROAD AND SOUTH LANE ADJACENT TO HILL ROAD REST GARDEN

圖號 DRAWING NO.
WIL/G03/0001/3

比例 SCALE
1:1000 (A1)
 或如顯示
 OR AS SHOWN

香港特別行政區政府
 THE GOVERNMENT OF THE HONG KONG
 SPECIAL ADMINISTRATIVE REGION

路政署
 HIGHWAYS DEPARTMENT

鐵路拓展處
 RAILWAY DEVELOPMENT OFFICE

XA:ADD:Library\MicroStation\WorkSpace\PlotDir\VPDF_Color_300dpi_080923.dft
 PRINTED BY: pking
 22/06/2002 16:54:57
 FILENAME: F:\CIP\WIL\POD\CIP\road closure\rev\Ver_A\signed\WIL-G03-0001-3.dgn